

***SPELEONICS* 28**

COMMUNICATIONS AND ELECTRONICS SECTION OF THE NATIONAL SPELEOLOGICAL SOCIETY

**Volume VII #4
June 2012**

Editor: Norm Berg, NSS 18567

SPELEONICS is published irregularly by the Communications and Electronics Section (CES) of the National Speleological Society (NSS). Primary topics include cave radio, underground communication, cave lighting, and data collection.

Contents of *SPELEONICS* 28 - Volume VII #4

Title, Table of Contents	1
About Speleonics, Editor's Notes, Executive Board, Meetings, Email List	2
CES Session Minutes July 18, 2011	3
CES Annual Meeting Minutes July 18, 2011	3
The Simplest Radiolocator: Cave Radios for Everyone. By Brian Pease	4
Cave Radios Help Coordinate Lava River Cave Graffiti Removal Project. By Jansen Cardy	14
Toward Better Electronic Cave Locks. By Curt Harler	15
Constitution of the Communication and Electronics Section of the National Speleological Society, 2002	16
Bylaws of the Communication and Electronics Section of the National Speleological Society, July 18, 2011	17
Websites and Groups of interest	19
System Nicola Mk3 Cave Radio. By Graham Naylor	20
Photos of CES meetings and field trips during the NSS Conventions of 2009, 2010, 2011	26
<i>Speleonics</i> Table of Contents for Issues #1(Spring 1985) – #27 (June 2011)	29

All issues of *SPELEONICS* are available online for FREE:
<http://www.caves.org/section/commelect/spelonic.html>

About Speleonics

SPELEONICS is the official newsletter of the Communications and Electronics Section (CES) of the National Speleological Society (NSS). In each issue, we strive to present a variety of articles relating to electronics as applied to caving and the study of caves.

Submissions to *SPELEONICS* can be contributed by both CES members as well as non-members. NSS membership is not required to be a contributor.

We welcome original or reprinted articles, photographs, and letters to the editor. Submissions, in digital format, should be sent to the editor (Norm Berg, nb1@cox.net).

The CES cannot publish copyrighted material without written permission of the copyright holder. Contributors are responsible for determining whether material is copyrighted as well as for securing appropriate permission.

Articles do not necessarily reflect the official position of the CES, NSS, newsletter editor, or the CES officers or members.

Unless independently copyrighted (©), material published in *SPELEONICS* may be reprinted in any NSS-affiliated publication, provided appropriate credit is given and either a hard copy or digital file made available to the author.

Editor's Notes

Welcome to issue #28 of Speleonics, which is my first as editor. I'd like to thank the past editor, Paul Jorgenson, for producing many fine issues, and for providing me with the template to use as a base for this issue. I'd also like to thank those that have taken the time and effort to write up their projects so that we may all share in those efforts and benefit from them.

As a reader of Speleonics, you may be working on cave-related electronics projects that would benefit the caving community as a whole. Please take the time to write up your project and have it published so that the caving community can share in your findings and knowledge. Email the editor. You will receive an email confirming your submission. The next issue of *Speleonics* is planned for the month prior to the 2013 NSS Convention.

The URL and email addresses in this publication are checked for accuracy prior to publication. If you find an address that is no longer valid, try doing an online

search for the author or specific subject. Many authors are NSS members and are in the NSS Members Manual, which is issued yearly by the NSS.

Norm Berg, Editor

nb1@cox.net (include "Speleonics" in the subject line) and 860-621-2080 before 9 pm Eastern Time

Executive Board

The Communications & Electronics Section is governed by an Executive Board consisting of four members. Elections are held at the annual business meeting during the NSS Convention.

The current executive board members are:

Section Chair: David Larson

Secretary-Treasurer: Brian Pease

Publications (*Speleonics* editor): Norm Berg

Communications (Webmaster): Aaron Birenboim

Meetings

During the week of the 2012 NSS Convention on Monday June 25 from 12-2 the C&E business meeting and lunch will take place. It will be followed by the C&E Session from 2-5 PM when papers will be presented and equipment demonstrated. We anticipate that there will be one or more field trips during the convention

Communications & Electronics Membership

You can become a member of the CES for a period of five years by simply signing the roster at a CES meeting at the NSS Convention, or by mailing or emailing the Section Chair or Secretary-Treasurer a request to be a member and providing your contact information.

Online Cave Electronics Discussion Group

To join the cave electronics discussion group and mailing list, go to <http://lists.altadena.net:80/mailman/listinfo/speleonics>. Being a member of the CES does NOT automatically add you to this discussion group. You must register separately.

Communications & Electronics Section Session Minutes

Brian Pease, Sec/Treas
7/18/11

Because of the need to leave early for the shuttle buses to the Howdy Party at Glenwood Caverns, We held "lightning talks" for those with informal short presentations prior to the official start of the session, with many people present from the Section meeting. Aaron Birenboim showed the "Dusi" electronic compass/clino with laser pointer and USB charging. It uses open source published software. Unfortunately the person who created it has quit and the website is gone, but Aaron has all of the info.

It was mentioned that there may be an updated Disto-X using a current Disto laser rangefinder. The Disto-X can be used to rapidly create "point clouds" of shots from a survey station to accurately define passage shape and dimensions.

Paul Jorgenson again showed his Signal Hound spectrum analyzer (signalhound.com), which covers 1Hz to 4.4GHz at a cost of \$919. It uses a laptop or netbook computer for processing and display and can do almost everything an expensive unit can do. There is now a new version with a preamp. An optional tracking generator that turns it into a scalar network analyzer is an additional \$600.

There is a compass/clino application for the Android Smartphone which could potentially be used for surveying by simply attaching a laser pointer. The calibration routine and repeatable accuracy are unknown and may not be good enough for cave surveying, which requires ~1% accuracy. This should work with older phones, which are available on Ebay for ~\$80.

David Larson described a simple homebuilt field phone system

using 2 Radio Shack amplifiers with built-in speakers as a base station, with just a speaker and Radio Shack matching transformer for the in-cave unit, with no switch at all. All of the parts are available at Radio Shack. The units operate at high impedance (500-1000 Ohms) just like the field phones, and are semi-compatible with them.

The first official talk was given by Bob Buecher on the results of his 2010 voice Cave Radio and Radiolocation tests in the left-hand tunnel at Carlsbad Caverns at ~750 ft depth. This is very dry low conductivity limestone. He used 185kHz transverters (Ian Drummond design) and 115kHz A.S.S. (Alberta Speleological Society) voice radios in both AM and SSB modes. SSB worked well with 1 meter square loop antennas but AM was marginal. Both modes worked well with 2 meter square loops. Maximum SSB range with the 1 meter antennas was 495 meters (236 meters vertical plus 435 meters horizontal). He managed a 750 ft depth radiolocation with my 3496Hz gear. He did 2 locations as an accuracy check, with surveys between the points on the surface and underground. The accuracy of the 3496Hz gear was ~3%. He has used the Pocket Digi PSK31 software with just acoustic links for text comms.

Brian Pease gave a talk on his recent high power radiobeacon designs. He described an 80 Watt push-pull 3496Hz beacon design, and also a 500 Watt 15kHz beacon with a 100 ft circumference loop that was tested for use in surface navigation. The details are in Speleomics 27.

Paul Jorgenson talked about HF communication tests also done in the left hand tunnel at Carlsbad, using tuned horizontal wires. He also showed a simple receiver using an LM386 that would work with one of my beacons to 200 ft depths in quiet areas.

Communications & Electronics Section Annual Meeting Minutes 2011

Brian Pease, Sec/Treas
7/18/11

The annual luncheon/meeting of the C&E Section of the NSS was held in room 1222 of the Glenwood Springs, CO High School 7/18/11 at the annual NSS convention. Free pizza was provided courtesy of Paul Jorgenson's employer, Sandia Labs. David Larson, Executive Chair, opened the meeting at 1230, announcing the in-cave radiolocation demo at Glenwood Caverns on Tuesday, and the availability of Speleomics #27 on our website. He also put out a call for articles for future issues of Speleomics and introduced the other officers. Norm Berg motioned that we pay for the C&E website for 10 years in advance since we have the money and no other expenses. This was seconded and approved by all. I gave the Secretary and Treasurer reports which were also accepted by all. We currently have \$1536.00 in a Non-Profit checking account. Including those who signed in at this meeting, we currently have 106 "active" members including 46 Hams.

David handed out copies of proposed additions/changes/deletions to the C&E bylaws. All references to dues were eliminated. The duties of the Publications Chair were changed to "Solicits articles

and edits Speleomics". The term of office for the new officers was changed to start immediately following the General Meeting and Session (if any) at the annual NSS Convention, instead of the following day. This was to allow for an Executive committee meeting the same day. The major change was to open up "membership" to anyone who by email or regular mail notifies the Executive committee that they wish to join, or remain, a member. This was seconded and approved by all.

Elections were run by Paul Jorgenson, who was stepping down from Publications Chair. Norm Berg was nominated to replace Paul (and accepted). David Larson will continue as Executive Chair, Brian Pease as Sec-Treas Chair, and Aaron Birenboim as Communications Chair. This slate was approved by all present. There was no old business.

Under new business, David asked when we should schedule a field day for next year. The consensus was that it should be during the week (Mon-Fri).

A sign-up sheet was circulated for those who wanted to attend the Field trip to Glenwood Caverns on Tuesday. The plan was to meet at the school at 1230, then carpool to the tram station where we would sign release forms prior to the ride up to the hilltop cave/amusement park. Radiolocation and through the Earth voice communications would be demonstrated with hands-on training.

The Simplest Radiolocator Cave Radios for Everyone

Brian Pease

ABSTRACT

The *Basic-1* Cave Radio addresses the need for a simple, short range, audio-frequency radiolocation and communication device that can be easily constructed, without test equipment, by anyone with basic soldering and wiring skills who has a rudimentary knowledge of electronics. It is really a throw-back to the original cave radios built and used in the 1960s, built as simple, light, and compact as possible. This article just describes the radios. Techniques for using them can be found at my website <http://radiolocation.tripod.com>.

Each Radio has the capability to act as either the surface receiver or as the underground beacon transmitter, which pulses 5 times per second. A good antenna is required to obtain useful performance from this simple circuit. A 48cm (19 inch) diameter circular loop with ~0.45kg (1lb) of wire serves as the antenna, parallel-tuned for receive and series-tuned for transmit. The simple 1750Hz circuit design uses a single 4-pin dual op-amp integrated circuit which acts as a preamp with 70 dB gain on receive, and as a free-running pulsed L-C oscillator on transmit with a magnetic moment of 1 Amp-turn-meter squared. 2-way CW (Morse Code) communication is possible between Radios. An optional built-in piezo sounder allows the underground unit to conduct transmitter monitoring and 2-way communications without bringing the large headphones underground. Older Amateur Radio operators have a real advantage here! Accurate ground zero locations are possible up to about 20 meters (67 ft) depths in ideal conditions, with 2-way communications theoretically possible to 60 meters (200 ft) depth if ground zero is already known. The *Basic-1* is ideal for lava tubes and other relatively shallow caves, pinpointing where isolated passages intersect, and for locating new entrances where the depth is not great. The *Basic-1* is powered by a single 9 Volt alkaline battery. The estimated battery life is 3 days of pulsing transmit operation, or 7 days of continuous receiving.

The *Basic-2* design adds a second ~0.45kg (1 lb) of wire to the loop and a second dual op-amp, which increases location depth to 30 meters (100 feet) and 2-way communications to 90 meters (300 feet) depth in theory. The magnetic moment is 2.8 Amp-turn-meter squared. Battery life is half that of the *Basic-1*. Information on the availability of printed circuit boards, certain specialized parts, and nearly complete kits for both designs, including the special headphones, is on my website.

HISTORY

This author has had many requests over the years from cavers (and others) with a need for radiolocation gear for specific, often shallow, projects. The high power beacons and the super-sensitive "DQ" receiver designed by the author many years ago for long range use are overkill for their needs and much too complex for them to construct and operate (see <http://Radiolocation.tripod.com>).

The most recent request (for which I provided training and loaned my high power gear) prompted a literature search for a simple circuit seen decades ago. An excellent article in a 1984 issue of 73 Magazine by the late Frank Reid was my starting point¹. As seen in **Figure 1**, Frank showed what is likely the simplest cave radio possible. When I simulated this circuit in LT Spice, I found that it worked fairly well as a simple regenerative receiver, tuned to the audio frequency of the L-C tuned circuit. When the key is closed, it does oscillate, but the loop current is measured only in microamps, restricting the range to a couple of meters. Attempts to increase the transmitter output failed, resulting in a serious frequency shift.

A series of experiments in Spice eventually evolved into the concepts shown in **Figure 2**. I chose essentially the same 48 cm (19 inch) diameter loop, with hundreds of turns, shown in Frank's article. The receiver is a classic non-inverting FET-input op-amp amplifier with high-impedance input and 70 dB gain. The parallel-tuned loop antenna consists of hundreds of turns of small wire, giving an impedance of ~23k Ohms and defines the receiver's bandwidth. This receiver has poor out of band rejection and suffers from some feedback between the dynamic headphones and the loop, but the simplicity is hard to beat.

The circuit is turned into a transmitter by simply moving one end of the loop to the output of the op-amp, which will oscillate due to strong positive feedback. Since the loop is now series-tuned, the L and C reactances cancel, allowing the op-amp to drive significant current (tens of milliamps) through the resistance of the wire. There is some downward frequency shift when transmitting, compared to the center frequency of the receiver, which can be compensated for. All of the other components present in the final design are only included to improve the operation of this simple circuit.

THE BASIC-1

This concept evolved into the *Basic-1* cave radio pictured in **Figure 3**, with the circuit of **Figure 4**, which adds biasing to allow the use of a single 9 Volt battery; input protection for the op-amp; T/R switching, CW keying, and a beacon mode that pulses the transmitter at 5Hz. The 600 Ohm headphones are crudely resonated to their broad natural resonance at the operating frequency

of 1750Hz. In addition to the tuned loop there are 3 low frequency roll-offs (4 if you count the loop) to help suppress 60Hz and its lower harmonics, plus a high frequency roll-off. There is a 1750 Hz sidetone for the CW and pulse modes, set to a reasonable volume that is independent of the receiver gain setting. The sidetone also acts as B.I.T.E. (Built In Test Equipment). You will not hear it unless the unit is actually transmitting. With the optional built-in piezo sounder, the underground unit does not need headphones for receiving or for the sidetone, making it very small and light. My desire to use a simple on-on-on 3-way toggle switch for the three modes (receive/CW transmit/pulse transmit) without added transistors or ICs resulted in some odd additions to the circuit. **Appendix A** gives the specifications and a detailed description of circuit functions. In ideal conditions, the *Basic-1* can radiolocate a point to about 20 meters (67 ft) depth with reasonable accuracy, with the signal detectable about 45 meters (150 ft) along the surface from ground zero. This limits the usefulness to small or shallow caves although one could theoretically communicate 60 meters (200 ft) straight down in quiet conditions if ground zero was known in advance.

THE BASIC-2

I decided to try to improve the range of the *Basic-1* without making it much more complex. The *Basic-1* loop uses 0.4 kg (0.9 lb) of #28 enameled wire with 332 turns. For the *Basic-2* I kept the 48 cm (19 inch) diameter but changed to 0.86 kg (1.9 lb) of larger #24 wire with 309 turns and a different resonating capacitor to maintain 1750 Hz. The *Basic-2* loop had a much lower resistance (higher Q) which resulted in improved receiver gain and selectivity and (potentially) higher loop cur-

Simplest 2-way audio frequency cave radio

From "Caveman Radio", Frank Reid, 73 magazine, Feb 1984

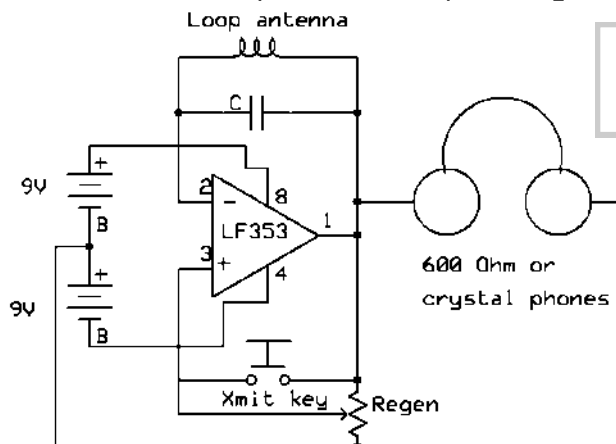

Fig 1. Simple Radiolocator
Frank Reid

This design is a regenerative receiver that is forced into oscillation when the transmit key is pressed. It appears to be good as a receiver, but transmits at an extremely low level which seriously limits range.

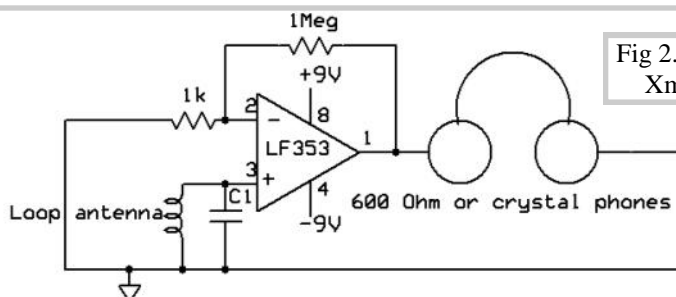
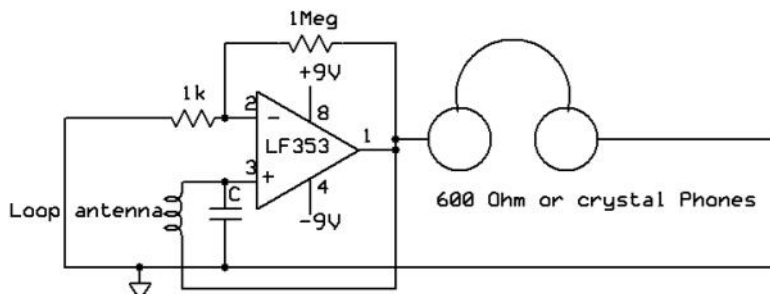

Fig 2. Simple Rcvr Simple Xmtr Basic Concepts

Simple audio frequency Receiver, basic concept

Hi-Z input non-inverting op-amp with +60dB ($\times 1000$) gain



Simple audio frequency transmitter, basic concept

Capacitor C and the loop antenna form a series-tuned circuit connected to the op-amp's output, with positive feedback causing oscillation.

The headphones provide a sidetone.

rent in transmit. Because the *Basic-1* circuit operates at the maximum current output of the single op-amp, I added a second IC with two additional identical op-amps in follower configuration in parallel with the original output (3 total) to boost potential output current x3 without other circuit changes, as shown in **Figure 5**. The simple DC connection with only 2.2 Ohm isolation resistors is possible because of the low (1 mv) laser-trimmed offset voltage of the LF412 op amp. This design boosted transmit loop current by nearly x3, increasing the beacon's output signal +9dB. The single 9V battery was retained.

Keeping in mind that the signal drops off as the cube of distance, the maximum depth increased to 30 meters (100 ft) with a horizontal distance of 70 meters (230 ft) from ground zero at this depth. Theoretical 2-way Comms depth at ground zero increased to 90 meters (300ft).

WHY HAVE 2 MODELS?

The primary reason for retaining the *Basic-1* is the very high cost of copper wire, currently about \$22.00 US/lb plus shipping, and predicted to rise much higher. Just the wire for a pair of *Basic-2* loops is ~\$100.00 US vs ~\$50.00 for a *Basic-1* pair. All of the other parts are inexpensive.

I have designed a PC board, using 100% thru-hole parts, that can be as-

sembled to make either a *Basic-1* or *Basic-2* unit. Upgrading from a 1 to a 2 requires only changing 2 component values and adding 4 parts. The hard part is re-winding the loop, or building a new one.

If correctly built, a *Basic-1* (with it's loop) can be used with a *Basic-2* (with it's different loop) because they will both be operating on 1750 Hz.

CONSTRUCTION

I will be offering PC boards and also nearly complete kits, including a PC board (which will build either radio), case, all electronic parts, and Telex headphones at my cost on my website <http://radiolocation.tripod.com>. Not included is the loop form, enameled loop wire, and 9V battery. Assembly instructions, photos, board layout, operation, etc will be posted on the website. It should be possible to construct 2 loops in one day, and assemble 2 radios from kits in another day, making this a weekend project.

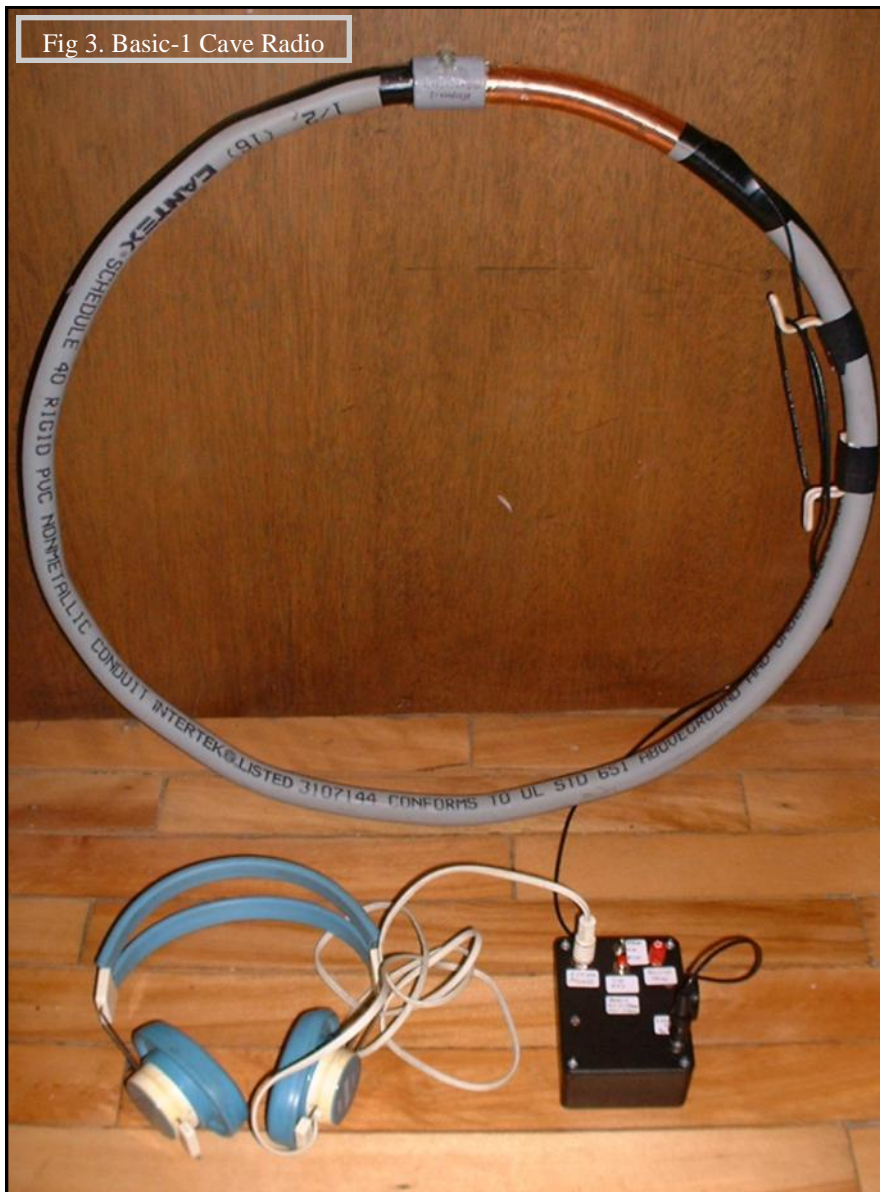
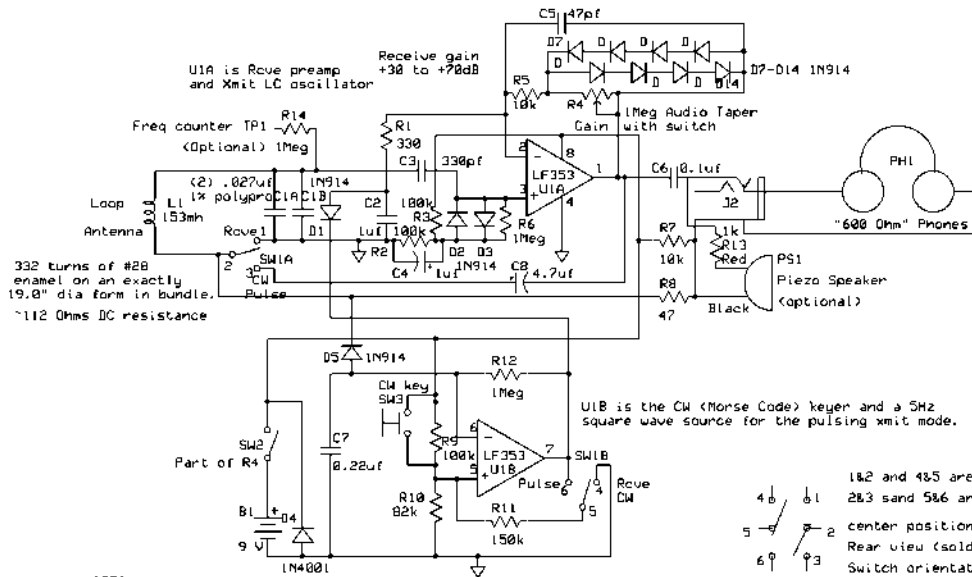

Fig 3. Basic-1 Cave Radio

I am including enough information here for an experienced builder to construct their own pair from scratch. See my website for more photos and details.

First, refer to **Appendix B** and scrounge all of the parts for the version you wish to build. Remember to multiply the quantities by 2 for two units. If a circuit board is not purchased, then some proto-board with holes on a 2.5 mm (0.1") grid should be purchased. I strongly recommend the expensive kind with plated-thru holes. My PC board is 1.25 x 2.5 inches (3.2 x 6.4 cm), but this is likely too small for hand wiring. The loop forms are builder's choice. Mine are formed from 1/2 inch ID (1.27 cm) gray PVC electrical conduit filled with sand then bent around a form (carefully) using a heat gun. A slot is then cut around the perimeter for winding. These are very light, can be transported over the shoulder, and don't blow around in the wind on the surface during searches. It is likely easiest to construct forms from stacked plywood disks. The core disk is 19.0 inches

Basic-1 1750Hz Cave Radiolocator and CW Communicator



DETAILED CIRCUIT DESCRIPTION

The Basic-1

Refer to the schematic in Figure 4

Receive Mode:

Looking at the *Basic-1* circuit of Figure 4, Loop L1 and C1 form a high-impedance parallel resonant circuit at 1750 Hz, which multiplies the received signal voltage by the "Q" of the circuit and also provides most of the receiver's selectivity. C3 and R6 aid selectivity by rolling off the response below 1750 Hz. R6 also provides 4.5V bias to U1 from the R3/R4/C4 divider. D2 and D3 protect the input of U1A, mainly during transmit. Op-amp U1A is wired as a high-gain non-inverting amplifier, with high input impedance, whose gain is $[(R4 + R5)/R1] + 1$. C2 provides a low frequency roll-off. At maximum gain, C5 rolls off the response above 1750 Hz. Diodes D7 – D14 are mainly for the transmitter, but also provide audio volume limiting for strong received signals. C6 roughly resonates the Telex 610 headphones at 1750 Hz, mainly providing another low frequency roll-off. PS1 (optional) acts as a built-in earphone and beacon monitor for underground use while R13 isolates the large capacitance of PS1 (.027uf) from the op-amp to prevent oscillation. Diode D5 grounds pin 6 of U1B in receive mode, forcing the output of U1B (pin 7) to +8 volts, which back-biases D1, allowing the receiver to operate. R7, R8, and all remaining parts (except the battery and reverse polarity protection diode D4) are used only for transmitting.

Transmit Modes

CW mode, key up:

C8 functions as a DC block allowing R7 and R8 to back-bias D5, which drops the output of U1B to 3 VDC (it is effectively just a voltage follower), causing D1 to conduct, shutting down U1A to prevent transmission.

CW mode, key down:

The output of U1B is forced up to +8 volts, back-biasing D1 which turns on the amplifier U1A. Amplifier U1A's circuitry remains unchanged except that the "grounded" end of the loop has moved to the output (pin1) of U1A. This causes strong positive feedback at the positive input (pin 3) near the L1/C1 series resonant frequency (1750 Hz), causing the circuit to oscillate strongly at a very slightly lower frequency. C8 is placed in series with C1 to raise the transmit frequency ~25 Hz to match the loop's resonant frequency during receive. R14 allows direct measurement of the transmit frequency with a counter or oscilloscope. D2/D3 limit the input voltage to a 1V peak-peak square wave. Diodes D7 – D14 also conduct, effectively shorting out the gain pot R4 to eliminate variations in oscillation frequency or amplitude due to different gain settings. The output on

pin 1 is ~6V p-p with the ~112 Ohm load of the series-resonant loop. This output is audible in the headphones and also in the optional piezo sounder. R7 and R8 attenuate this "sidetone" to a reasonable level. 18 mA rms is forced through the loop. As cave radios go, this is not much current, but it is circulating in more than 300 turns of wire. The strength of the transmitted magnetic field is determined by the Magnetic Moment, which is just the AC (rms) current flowing in the loop in Amps, multiplied by the number of turns and also multiplied by the area of the loop in meters squared.

Pulse mode:

D5 remains back-biased but R11 is now connected, providing positive feedback (hysteresis) to U1B, which begins to oscillate as a multivibrator at ~5Hz, producing a square wave output at pin 7 that causes D1 to turn U1A on and off at a 5Hz rate. This gives the same result as pressing the key 5 times/second in the CW mode. C7 and R12 set the rate, which is approximately $1/(C7 * R12)$ Hz. Because R9 and R10 are not equal values, the "on" duty cycle of the transmitter is actually slightly less than 50%.

Basic-2

Refer to the schematic in Figure 5

Receive Mode:

The receiver functions exactly the same as the *Basic-1* except for a few extra dB of gain due to the reduced losses of the heavier loop. The second LF412, U2, does nothing to aid reception. C1 is a different value to resonate the different inductance of the Basic-2 loop to 1750 Hz.

Transmit Modes:

Both modes function exactly the same as the *Basic-1* except that U2 provides a big current boost to the square wave output to enable it to drive the 40 Ohm series-resonant load of the *Basic-2* loop. U2A and U2B are connected as unity gain followers with their outputs in parallel with U1A. Resistors R15-17 isolate the 3 outputs from each other (and from pin 1) while introducing negligible loss. The low value of 2.2 Ohms is possible because the LF412's are laser trimmed for a DC offset (input to output) of <1mV and because the gain is so close to unity. The use of LF353's would require 10 Ohm resistors for R15-17. The three op-amps in parallel have 3 times the output current capability of U1A alone, forcing 45mA through the loop (and 60 V rms across it!). There are only 2 other minor circuit changes. One is C8, whose value is lowered from 4.7uf to 3.3uf to raise the transmit frequency slightly more than the *Basic-1*. The other is the addition of D6 in series with D5 to prevent conduction during transmit with the more robust output waveform, which would lock the transmitter "on" and prevent pulsing.

APPENDIX A

Specifications and detailed circuit description

SPEC	BASIC-1	BASIC-2
RECEIVER		
Input impedance	1 Megohm	1 Megohm
Bandwidth (-3dB)	130 Hz	75 Hz
Bandwidth (-30dB)	670 – 6190 Hz	975 – 3579 Hz
Battery	One 9V	One 9V
Battery current, receive mode	3mA	8mA
Battery life	~7 days	~3 days
Loop (48cm/19" dia)	153mh, 332 turns #28	121.6mh, 309 turns #24
DC loop resistance	~112 Ohms	~40 Ohms
Loop weight	0.4kg (0.9 lbs) plus form	0.9kg (1.9 lbs) plus form
Radio weight, with battery, less headphones	170 grams (6 oz)	170 grams (6 oz)
Parallel resonant loop impedance	23k Ohms	40k Ohms
Headphones	Telex 610 (600 Ohms)	Telex 610 (600 Ohms)
Receiver electronic gain	+30 to +70dB adjustable	+30 to +70dB adjustable
TRANSMITTER		
Pulsing rate	5Hz	5Hz
Magnetic Moment	1 Amp-Turn-Mtr ²	2.6 Amp-Turn-Mtr ²
Battery current	12mA key down, ~9mA pulse	28mA key down, ~18mA pulse
Transmit power (heat in loop)	~40mW	~90mW
Battery life	~3 days pulsing	~1.5 days pulsing
Loop voltage	30V rms	60V rms
Loop current	18mA rms	45mA rms
Maximum radiolocation depth*	20 meters (67 ft)	30 meters (100 ft)
Max reception distance from ground zero at max depth*	45 meters (150 ft)	70 meters (230 ft)
Max depth for 2-way comms* (estimated)	60 meters (200 ft)	90 meters (300 ft)

* These estimates are for an experienced crew with little man made or atmospheric noise, fresh batteries, and typical limestone conductivity (not Florida or the tropics).

APPENDIX B
PARTS FOR A SINGLE BASIC-1 UNIT
 See other table for single Basic-2 parts

ITEM	QTY	DESCRIPTION	PART # or SOURCE	COST
B1	1	Standard 9V battery	Local	-----
*C1A,B	2	.027uf, 3%, 800V polypropylene cap	P14260-ND	\$0.82
C2	1	1uf 50V X7R ceramic	DigiKey 478-4657-ND	\$0.86
C3	1	330pf 100V NPO ceramic	399-4173-ND	\$0.40
C4	1	1uf 35V tantalum (16V ok)	478-5812-ND	\$0.40
C5	1	47pf 50V NPO ceramic	399-4181-ND	\$0.43
C6	1	0.1uf 50V ceramic	478-3188-ND	\$0.24
C7	1	0.22uf 50V ceramic	399-4288-ND	\$0.65
*C8	1	4.7uf 16V tant	718-1220-ND	\$0.86
D1-3,5,7-14	12	1N914/1N4148 silicon signal diode	RS 276-1620	\$2.99/50
D4	1	1N4001 power diode (or similar)	RS 276-1653	\$2.99/25
*L1	~0.9 lb	332 turns #28 enamel 19.0" dia, ~1750 ft	Tech-Fixx, Ebay, Amazon (industrial & scientific section)	\$17—\$22/lb
PH1	1	Telex 610 series 600 Ohm mono phones	Ebay (my qty purchase)	\$3.55
PS1	1	Piezo speaker (optional)	RS 273-073	\$2.19
R4	1	1Meg audio taper mini pot with switch	CT2222-ND	\$3.85
R1	1	330 Ohm ¼ W 5% carbon comp resistor	RS 271-312	\$9.99/500
R2,3,9	3	100k " "	All resistors are in	
R5, R7	2	10k " "	The 500 piece	
R6,12,14	3	1Meg " "	Radio Shack	
R8	1	47 Ohm " "	assortment	-----
R10	1	82k " "	(or DigiKey or Mouser)	
R11	1	150k " "	One value \$0.06 ea	
R13	1	1k	In qty 10 at DigiKey	
R15-17	3	2.2 Ohm " "		
SW1	1	3-way on-on-on mini toggle switch	Ebay (my qty purchase)	\$1.00
SW2	0	Part of R4	-----	-----
SW3	1	Momentary push button, norm <u>open</u>	M.P.Jones 5019-SW	\$0.29
U1	1	LF353 or TL082 dual BiFET op-amp (LF412 is better and recommended)	RS 276-1715 296-7141-5-ND	\$2.19 \$0.76

APPENDIX B continues >

Parts for a single Basic 1 unit — continued

ITEM	QTY	DESCRIPTION	PART # or SOURCE	COST
L1 plug	1	RCA phono plug with cable clamp	RS 274-451	\$3.99/6
L1 jack	1	RCA phono jack with threaded mount	RS 274-346 MPJA 5522-PL	\$4.19/4 \$0.34
PH1 jack	1	1/4" or 1/8" to fit phones (no switch)	RS 274-252 or 274-0248	Local
*DIPsocket	1	8 pin DIP socket	RS 276-1995 A100204-ND	\$0.59 \$0.12
PC board	1	Miniboard service (9/\$51.00 + ship)	ExpressPCB	\$6.87
Box	1	Plastic box, screw-on lid, 3x4x1.5" high	M. P. Jones 15523-BX	\$2.49
B1 holder	1	Snap-in 9V battery holder with 6" leads (tape mounted)	BH9VW-ND	\$1.30
Tape	2"	Double-sided sticky tape for Bat holder and optional piezo speaker	Local	-----
Knob	1	Volume control Knob (R4 has 1/8" shaft)	See notes below	-----
Coax	5.5 ft	5 ft RG-174 feedline for loop plus 6" for PC board wiring	Ebay	-----
Wire	6 ft	#26 hookup wire PC board 2 ft of 3 colors	Local	-----
Hardware	2 sets	4-40 x 1/2" FH screw/nut/spacer 1/8" spacer cut from plastic tubing	Local	-----
Hand gnd	2 ft	1" wide copper foil	I have a supply (SASE)	-----
Tape		Vinyl electrical tape for loop (if needed)	Local	-----
Shrink tube		Small tube, loop wire splices (if needed)	Local	-----
Circ level	1	Circular surface level for cave loop	Local	-----
Line level	1	Line or RV level for surface loop	Local	-----

Additional parts (or changes) for a single Basic 2 unit

ITEM	QTY	ADDED OR CHANGED PART	PART # or SOURCE	COST
C1	1	Replace(2).027uf with(1).068uf 3% 400V	P12083-ND	\$1.68
C8	1	Replace 4.7uf 16V tantalum with 3.3uF	718-1217-ND	\$0.76
D6	1	1N914/1N4148	See D1	
L1	~1.9lbs	309 turns #24 enamel 19" dia, ~1545 ft Replaces the 0.9 lb #28 Basic-1 loop	Same source	Similar/lb
R15-17	3	2.2 Ohm ¼ Watt carbon film resistor	RS assortment	
U1,U2	2	Must be LF412 for Basic-2 due to high output and low DC offset (see text)	296-7141-ND	\$0.76
DIP socket	1	A 2 nd 8-pin DIP socket is required		

Notes on parts in Appendix B

Most of the Radio Shack parts are available from the other suppliers. Mouser.com is another good supplier. DigiKey has other choices for most of the part numbers shown.

Radioshack.com (RS parts)
 digikey.com (ND parts)
 mpja.com (M.P.Jones parts)

For knobs for 1/4" shafts go to Radio Shack. For 1/8" shafts try allelectronics.com KNB-127 for \$1.27 ea, or surplussales.com (KNB)PKG50B1/8 or (KNB)RN-99F1 for \$2.00 ea.

M.P. Jones has the 4 ceramic capacitors very cheap. I have some non-adhesive 1" wide copper foil for shielding for free. Send SASE.

I have the Telex 610 Headphones for \$4.00 plus shipping.

The circular level is a standard item available in most hardware stores. The line level (designed for hanging on a string) is available at Home Depot. The 3/8" diameter cartridge snaps out of the holder. Smaller stick-on levels can be found at an RV/trailer dealer, used to level trailers.

Resistor	Value (Ohms)	Color Code
R1	330	Orange, orange, brown, gold
R2,3,9,10	100k	Brown, black, yellow, gold
R5	10k	Brown, black, orange, gold
R6,12,14	1Meg	Brown, black, green, gold
R7	4.7k	Yellow, violet, red, gold
R8	47	Yellow, violet, black, gold
R11	150k	Brown, green, yellow, gold
R13	1k	Brown, black, red
R15-17	2.2	Red, red, gold, gold

Color codes for the brown 5% carbon film resistors. There are 4 color bands with the last band being gold, which indicates 5% tolerance. 1% resistors are blue and have 5 color bands. A quick Ohms check with a cheap Digital Voltmeter is a good idea. Sears often has a good meter on sale for \$10.00, Harbor freight for \$5.00.

NOTE: The oriental perception of colors, especially brown and violet, red and orange seems to be different from mine. I often have trouble distinguishing between them unless they are side by side.



Better Caving Through Electrical Stuff

Cave Radios Help Coordinate Lava River Cave Graffiti Removal Project

Jansen Cardy
September 24, 2010

On the weekend of September 18 and 19, 2010, approximately 20 caver volunteers and 2 Forest Service employees participated in a major graffiti removal project at Lava River Cave near Flagstaff. Cavers from Escabrosa

Grotto, Southern Arizona Grotto, Central Arizona Grotto, and Northern Arizona Grotto participated in the project, which also doubled as the Fall 2010 Arizona Regional Association campout. On Friday, 3800 feet of high pressure air hoses were laid the length of the lava tube. A couple of project volunteers also assisted a woman

out of the cave that afternoon, after she slipped and suffered a head injury a few hundred feet inside the entrance. She was driven to Flagstaff for further medical attention.

On Saturday morning, the day started around 9am with an introduction and safety brief by Ray Keeler of CAG and the Coconino Forest Volunteer Coordinator. We then carried equipment to the far end of the cave and began the sandblasting process. This area of the cave had the most graffiti, including the infamous stubborn "green dot." This was a large round piece of artwork which took several hours of work to remove. Previously an off-duty police officer visiting the cave with his family had recognized the tag and reported to the Forest Service. It was apparently painted by an art student who stayed in the US after his student visa expired. He has since been apprehended.

With the use of amateur radio equipment, including Yaesu FT-817 portable HF rigs and various VHF handhelds, we were able to maintain communication between the work area and Ray back on the surface with the

large trailer-mounted air compressor. As the day progressed, we had three sandblasting crews and several people with wire brushes working at the same time. We were careful to lay down tarps to catch the glass bead blasting media, and in most cases we also held tarps up like a shower curtain around the people blasting. Rich Bohman from CAG was our underground coordinator, and he did a fine job of getting everybody operating efficiently and with minimum impact to the cave. He also explained the project to visitors, including an excited group of visiting Cub Scouts. They were among the hundreds of casual visitors constantly tramping past

us in the cave during the course of the weekend.

We finally exited the cave that day around 6pm, in time for a fantastic burger and hot-dog dinner kindly provided by Larry and Christina Zimmer of NAG. This was followed by a casual evening ARA meeting around the campfire. On Sunday morning, we were back into the cave around 9am. We had three hours to remove

about a dozen remaining tags spread throughout the cave, and with several sandblasting teams working different areas at the same time it was a slick operation. Finally, around noon, everything was switched off and we packed up and pulled all the remaining equipment out of the cave. Another successful project completed!



Cavers removing graffiti in Lava River Cave (Jansen Cardy)



Underground radio operator Teresa Bohman in Lava River Cave (Jansen Cardy)

Toward Better Electronic Cave Locks

Curt Harler

We all can look forward to the day when an electronic locking system can be installed on cave gates nationwide. The locks will be controlled by a central point (say NSS Headquarters) or by trusted locals (say a nearby grotto). The access codes can be changed daily (even hourly, if needs be).

Since there would be electronic codes, physical keys would not be required. Nobody would have to pick up a key, keep track of keys, or recover lost and missing keys. Simply, any paid-up NSS or grotto member could be given the electronic access number to any cave over the phone or Internet. They would not have to "return" the key. The access code simply would change after 24 or 72 hours – or whenever the controlling group needed to change it.

While gates do keep out partying locals and riff-raff, they also deny access to legitimate and gentle cavers. In some areas of the country access to caves has become a matter of jealous and exclusive privilege for a self-anointed elite. Sport cavers usually suffer.

An electronic lock system for caves would grant access through a remote satellite or similar system that would beam a time-stamped access code to the lock. The property manager could share that code number with an approved Grotto that wanted to see the cave. Although access codes would change constantly, the person controlling the cave would know exactly who was in the cave and for how long. In addition to simple entrance, access could be granted by providing a code that would be active only for a period of time (say Saturday, March 2 from 9 a.m. until Sunday, March 3 at midnight – allowing ample time for the cavers to get in and out without being trapped by the locks).

I know that, in the case of some caves, landowners legitimately want access restricted so spelunkers will not get into trouble. That is the landowner's prerogative. However, creating a privileged bloc with sole access privileges (or virtually exclusive use) is not right, either. The current brass key system encourages just that kind of jealous restriction of access. With electronic locks, NSS member-cavers might use their NSS number plus a code to gain access to caves with electronic locks. It would be as simple as that.

Data for electronic locks can be downloaded just like any other radio transmission. Many services provide such updates today (retail price updates, custom music, etc.). The radio overhead for the project would be minimal. The ongoing cost should be reasonable and, in my opinion, a good use of NSS moneys. Gates located underground would require an outside antenna "view" to get

the signal, but that is a minor consideration to fix.

With electronic locks, the NSS would have a good handle on who was caving and how much time is spent underground (great research data that today has to be gleaned from cave registers). Individual cavers would have a great source of data for their personal trip logs, knowing exactly how many hours they spent on each trip. If a cave were to be vandalized, everyone would know who was in the cave when the damage occurred. In addition to providing court-admissible evidence about who was at the crime scene, the offender's number simply would be put on a list to deny entry to all caves on the system.

Best of all, cavers from any area of the country would and could visit distant locales without having to worry about access beyond an email or phone call.

Meantime, there is another concept that works. Real estate agents already have a great system for locking up properties – and that system could include caves. Think about it: the Realtor's needs are similar to ours. If an agent has someone interested in a vacant property, the showing agent needs to be able to get in. However, the listing agent might not be able to get out to the property site or it may be inconvenient. The property must be secure the rest of the time. And, the homeowner has a right to know who is in the property and when...without having to be present every time an agent wants to sell it. In the past, real estate agents used lockboxes. A house key was in the lockbox. The problem was that every real estate agent in the country had access willy-nilly and nobody could tell who was present in the home or when the property was entered. And, it was fairly easy for bad people to get access to a lockbox key.

The same problems face those who control access to wild caves: transporting the key, monitoring use, keeping bad guys out.

Today, many real estate agents use a different system. The key to the property (think cave versus house) is still locked in a lockbox. But the lockbox is electronic. And the real estate agent (think Grotto activities chair or site manager) has an electronic transponder with a special code that allows access to the lockbox and pops it open if the code sent to the Real Estate agent's beeper or cell phone is authorized by the lockbox. Voila! The key pops out and the agent can go into the property...but the system knows which agent was in and for how long.

The transponders are the size of a typical basic cell phone. The lockboxes pop open after the agent pounds in a pass code. What a beautifully simple system for cave locks! The person in charge of cave access rarely has to be at the cave. The key to the cave is locked in the electronic box. When access is required, the cave manager simply approves, say, the Cleveland Grotto's transponder code for access. Every Grotto could have a couple of these transponders available to members (say one for the Grotto's Vertical Chair if he were to

go pit-bouncing in West Virginia and one the Activities Chair could take along for a beginner trip requiring access to a suitable cave in Indiana). Yes, an individual could lend a transponder to someone else – but responsibility would still reside with the transponder's holder, since it would be in their access code.

A company called SentiLock in Cincinnati has such a unit. It works with a key card similar to that given to a hotel room guest. While marketed to real estate agents, the SentiLock has some features cavers would like including an integrated and illuminated keypad, an extra large front opening key compartment, optional cardless entry, and a small, inexpensive and convenient electronic key device. SentiLock's system is Web based so all lockbox settings and visit information are accessible from any Internet connected PC. It's been out on the market for a short while.

Even simpler, a unit like the Supra 001872 Designer Key Box from GE (about \$50) requires a cave manager to go to the site to change the access code – a task anyone can do at their leisure or on their way home from work – but still records the access codes of the last nine people to go into the cave.

Real estate agents in places as diverse as York and Adams County, Pa.; Sarasota, Fla.; Denver, Colo. and Hilton Head, S.C. all use the electronic systems. Surely there must be a caver amongst them who could verify or destroy this concept. If it works, it offers something for everyone: Better, easier control of the cave for the cave manager and easier access to caves for NSS members. What else could we want?

CONSTITUTION of the COMMUNICATION & ELECTRONICS SECTION of the National Speleological Society — 2002

NAME The name of this organization shall be the Communication and Electronics (C&E) Section of the National Speleological Society.

PURPOSE The purposes of this organization shall be the same as those of the National Speleological Society, with the additional purpose of organizing NSS members and others with an interest in communications and electronics to better promote the objectives of the NSS.

GOVERNING (1) The Communication and Electronics Section shall be governed by an Executive Committee made up of the following officers (Chairs) elected annually by the members: (a) Executive Chair, (b) Secretary-Treasurer, (c) Communications, (d) Publications. (2) The Executive Committee shall have complete power to manage the business of the Section. (3) Decisions or actions of the Executive Committee may be overruled by a two-thirds majority vote of the members.

MEETINGS (1) Executive Committee and General Meetings shall be held at such times and places as are determined by the committee. (2) A petition signed by two-thirds of the membership shall be mandatory upon the Executive Committee to call a special meeting for the purpose stated in the petition.

MEMBERSHIP (1) Full Membership is limited to members of the NSS. (2) Other classifications of membership may be defined in the bylaws.

NATIONAL SPELEOLOGICAL SOCIETY Constitution and Bylaws of the National Speleological Society shall be binding on the Communication and Electronics Section. Any action inconsistent therewith shall be null and void. In the event of dissolution of the section, all assets remaining after meeting outstanding liabilities shall be assigned to the National Speleological Society. However, if the named recipient is not then in existence or is no longer a qualified distributee, or unwilling or unable to accept the distribution, the assets of this organization shall be distributed to a fund, foundation, or corporation organized and operated exclusively for the purposes specified in Section 501(c)(3) of the Internal Revenue Code of 1954 (or the corresponding provision of any future U.S. Internal Revenue Law).

AMENDMENTS Amendments to this constitution may be proposed either by the Executive Committee or by a petition of ten percent of the members in good standing. Adoption of the amendment(s) shall require a three-quarters vote of the members voting, provided that notice of the General Meeting and the content of the amendment(s) shall have been announced to the membership by mail, email, or at a meeting at least 30 days prior to the time at which the vote will be taken. The total votes cast must constitute at least 51% of those members who sign in at the meeting where the voting takes place.

(Revised 2002)

Copyright © 2002 Communications & Electronics Section of the NSS, Inc. - All Rights Reserved.

Bylaws Communication and Electronics Section Of the National Speleological Society — July 18, 2011

MEMBERSHIP

The Membership consists of (1) those who attend an annual General Meeting and/or the C&E session at the Annual NSS Convention and who sign the roster with their name and email (or regular) address and (2) those who, by email (or regular mail) notify a member of the Executive committee of their desire to become, or remain, a member. The duration of membership shall be 5 years from the last meeting attended, or the last notification.

Applications

Applications for membership shall be in writing, as specified above. All applications for membership shall be acted on by the Executive Committee. There shall be two classes of members:

Full: Is an NSS member, has full voting rights, may hold office, and receives any generally distributed publications.

Associate: Is not an NSS member, may vote on matters not affecting the NSS, may not hold office, and receives any generally distributed publications.

Dues

There shall be no dues.

Termination of Membership

Membership may be terminated if the member fails to respond to inquiries by email or regular mail from a member of the Executive Committee.

Expulsion

Members may be admonished, suspended from certain privileges, or expelled from Section membership for any of the following reasons:

- (1) Willful misuse of Section property or facilities.
- (2) Willful disregard of the safety of themselves and/or others while participating in a Section activity.
- (3) Conduct detrimental to the Section and/or the National Speleological Society.

Disciplinary action under this provision shall be taken only upon a three-quarters vote of the Executive Committee by a secret ballot. Disciplinary action shall be initiated only upon presentation to the Executive Committee of a written petition for disciplinary action, submitted by at least two members of the Section not in the same household.

Upon receiving such a petition, the Executive Committee shall take such actions as are deemed necessary to notify the accused members or members, in writing, of the petition, and of the place, date, and time at which the petition will be considered by the Executive Committee. The accused member or members shall have the right to speak on their own behalf. Such considerations shall take place no sooner than twenty-one days and no later than seventy days after the Executive Committee receives the petition.

ASSESSMENTS AND GIFTS

No special assessments may be made against members of the Section. The Executive Committee may solicit voluntary contributions of money or time for specific purposes. A charge may be made for the Section's special publications and extra copies of regular publications, and fees may be collected for the use of the Section's property when approved by the Executive Committee.

Gifts and bequests may be made to the Section in any form or amount and for any use compatible with the purpose of the Section.

A charge may be made to non-members for: attendance at Section-sponsored activities; use of the Section's equipment and library; copies of publications, maps, and other data, and inclusion of non-members on the Section's mailing list.

EXECUTIVE COMMITTEE

Duties

In addition to the general duties of governing the Section, the Executive Committee members shall have the following specific duties:

Executive Chair: The Executive Chair shall be the executive head of the section: call and conduct meetings; prepare and submit the yearly report to the NSS; create and maintain a membership database; and shall be the designated Section contact person.

Secretary-Treasurer Chair: As Secretary, the S-T chair shall keep the minutes of all general membership and Executive Committee meetings, maintain all Section correspondence except for that which has been delegated to other officers by the Ex-

Executive Committee, and maintain a file of all Section directives. As Treasurer, the S-T chair shall care for all funds of the Section and disburse and manage the funds as directed by the Executive Committee; distribute back issues of Speleonics; and be prepared to provide a report of the treasury status at any meeting.

Communications Chair: The Communications Chair shall be responsible for publishing the Section Web Pages including the electronic version of the newsletter Speleonics.

Publications Chair: Solicits articles and edits Speleonics.

Elections

Executive Committee Elections will be held during the annual General Membership Meeting of the Section at the NSS convention. The Executive Chair with approval of at least two-thirds of the rest of the Executive Committee members shall select candidates for the Executive Committee from among the Section members (who are also NSS members). The Executive Chair shall appoint one of the Section members to act as moderator and preside over the elections. The moderator shall not be a candidate in the upcoming election that they are moderating. Additional nominations of members may be made from the floor at the general meeting provided that such nominations are seconded and subject to acceptance by the member so nominated. Approval of a candidate shall require 51% of the members voting.

Term of Office

Those elected each year shall take office immediately following the close of both the General Meeting and C&E Session (if any) at the annual NSS Convention.

The Executive Committee shall have the power to remove any Executive Committee member who, without just cause, fails to fulfill the duties of their office, including simple neglect, in such a manner as to cause potential harm to the Section.

Vacancies on the Executive Committee that occur shall be filled for the balance of the term by chairman's appointment, subject to majority approval of the rest of the Executive Committee.

Proxies

Any member of the Executive Committee may appoint a member of the section as a proxy to act for him or her at a meeting of the Executive Committee. Proxy may act at one meeting for only one Executive Committee member. The presiding officer must be notified of such proxy appointment directly or in writing by the absent Executive Committee member before the proxy may be allowed to serve. Authorization should state if discretionary voting powers have been given to the proxy.

Other Attendees

Committee chairmen may attend meetings of the Executive Committee and have the privilege of speaking on matters relevant to the committee's function but shall have no power to vote by virtue of their chairmanship. Any other member of the section may attend Executive Committee meetings and may be granted the privilege of the floor at the discretion of the presiding officer but shall have no power to vote.

Executive Committee Meetings

There shall be at least one Executive Committee meeting each year, generally at the annual NSS Convention after the close of both the General Meeting and C&E Session. The time, place, and date shall be provided to the membership before the date of such meeting. The Executive Committee shall determine the date, time, and place for any special meetings. A quorum at an Executive Committee meeting will be fifty percent of the members of the Executive Committee.

Directives

Each action approved by the Executive Committee, which establishes new policies or administrative procedures can be designated as a "directive" or "act". The secretary of the Section can be made responsible for maintaining a file of such directives and be responsible for notifying the membership directly or in writing of their adoption. This is similar to "standing orders," described in Roberts Rules. This is optional.

GENERAL MEETINGS

There shall be at least one General Meeting of the membership each calendar year. The date, time, and place of this meeting, normally at the annual NSS convention, shall be provided to the membership before the date of such meeting. The Executive Committee shall determine the date, time, and place for these and any special meetings.

A quorum at a General Meeting shall be 51% of those members who are present at the meeting.

PARLIAMENTARY AUTHORITY

Robert's Rules of Order, as revised, shall govern all procedural questions arising at all meetings of the Section when they are applicable and when they are not inconsistent with the Section's constitution and bylaws.

COMMITTEES

Committees shall be established by the Executive Committee to execute the work of the Section. Chairs of the committees

shall be appointed by the Executive Chair of the Section, subject to the approval of the Executive Committee. Each committee chairman shall select shall select the personnel and promote the activities of his committee. All committees will operate under the direction and approval of the Executive Committee other than the Elections Committee.

FINANCES

The Section may acquire real and intangible property, including equipment, literature, and other materials for use by and on behalf of the membership. The fiscal year is the calendar year.

PUBLICATIONS

The Section will issue and distribute to the members in good standing issues of Speleonics when they are published, through the section's website or by other means. The Section is also empowered to issue and distribute special publications, subject to regulations governing the subject matter, publication dates, sales, and distribution as prescribed by the Executive Committee.

STORE

The Section may maintain a Section Store for the convenience of members, friends, and associates, which will be limited to speleologically related goods appropriate to the policies of the Section.

DISSOLUTION

In the event of dissolution of the Section, all assets remaining after meeting outstanding liabilities shall be assigned to the National Speleological Society. However, if the named recipient is not then in existence or is no longer a qualified distributee, or unwilling or unable to accept the distribution, the assets of this organization shall be distributed to a fund, foundation, or corporation organized and operated exclusively for the purposes specified in Section 501 (c)(3) of the Internal Revenue Code of 1954 (or the corresponding provision of any future U.S. Internal Revenue Code).

AMENDMENT

All proposed amendments in these bylaws must be presented to the entire membership and notice given to the members of the place, date, and time of the General Meeting at which the amendment(s) will be considered for adoption. This notice shall be given not less than twenty days prior to the designated meeting. Adoption of the amendment(s) shall require a two-thirds vote of the members voting, and the total votes cast must constitute at least 51% of the full members who sign in at the meeting where the voting takes place.

Websites and Groups of Interest

Cave Radio & Electronics Group

bcra.org.uk/creg/index.html



CREG

The UK-based Cave Radio & Electronics Group (CREG) is probably the world's leading organisation of its kind. Its aims are "to encourage the development and use of radio communication and other electronic and computer equipment in caving and related activities". CREG's main role is one of information gathering and dissemination.

The NSS Online Forum — Cavechat

www.cavechat.org



Technical discussions relating to communications and electronics can be found in several forum sections, including the equipment forum, cave rescue forum, survey and cartography forum, and photography and videography forum.

Better caving through electronic stuff.

CaveSim crawl-through electronic cave simulator

www.cavesim.com



CaveSim is an electronic caving experience for beginning and experienced cavers of all ages.

In-Cave Data Logger Project

www.caves.org/grotto/ccg/datalogger/index.htm

A project of the Central Connecticut Grotto to develop a data logger to log caver traffic and environmental conditions in caves.

System Nicola Mk3 Cave Radio

Graham Naylor

The system Nicola 3 follows on from the Nicola 2 designed in France in the late 90's and the Heyphone developed in the UK at about the same time. It follows in the tradition of the Nicola 2 radio in that it aims to be easily produced in series and be of a design that could be reproduced in subsequent batches. Like the Heyphone and Nicola 2 and also the preceding UK cave radio the molefone, it makes use of Single Side band modulation (USB) at 87kHz (actually the N2 operates at 86.95kHz for obscure reasons). While the performance of modern electronic circuits continues to improve the ability to reproduce a particular design of radio over an extended period of time is increasingly being challenged by component obsolescence. The Nicola 3 aims to avoid to some extent these issues by being a completely programmable design using generic components and circuits. Two years ago I felt we were just about to go into production when the Bluetooth chip used to pass the audio signal to and from a BT headset, from and to the waterproof N3 box itself switched to 'lifetime buy' status (i.e. kiss of death). The board was a 4 layer design using an on-board FPGA and not something to be re-designed quickly. This prompted a re-think of the strategy (though the basic principle was sound) and the whole project took a major delay. The board is now re-designed as a 2 layer board with only the essentials, while components susceptible to 'evolve' (i.e. become obsolete) were placed on separate boards. In this way the new Bluetooth chip is mounted on a small board which connects to the main board via a 12 pin PMOD standard connector and a commercial (COTS) board used with the FPGA on it (from OHO a German company). This increased only marginally the build cost, but allowed it to be a lot more 'agile'.

The Nicola 3 is a completely programmable platform and although the initial programming is to perform 87kHz SSB on USB, the hardware would equally well support any frequency in the range 2-200kHz using any modula-

tion method you care to define in the programming (e.g. text/data). Conceptually then, the hardware design is very simple.

An ADC to receive the antenna signal (A couple of op-amps with 60dB of gain and a pre-amp with just over 40dB of adjustability to bring the level up to that expected by the ADC). One of the op-amp stages performs a slow roll-off low pass function (around 150kHz) to reduce aliasing of the ADC, yet maintain a high bandwidth delivered to the FPGA.

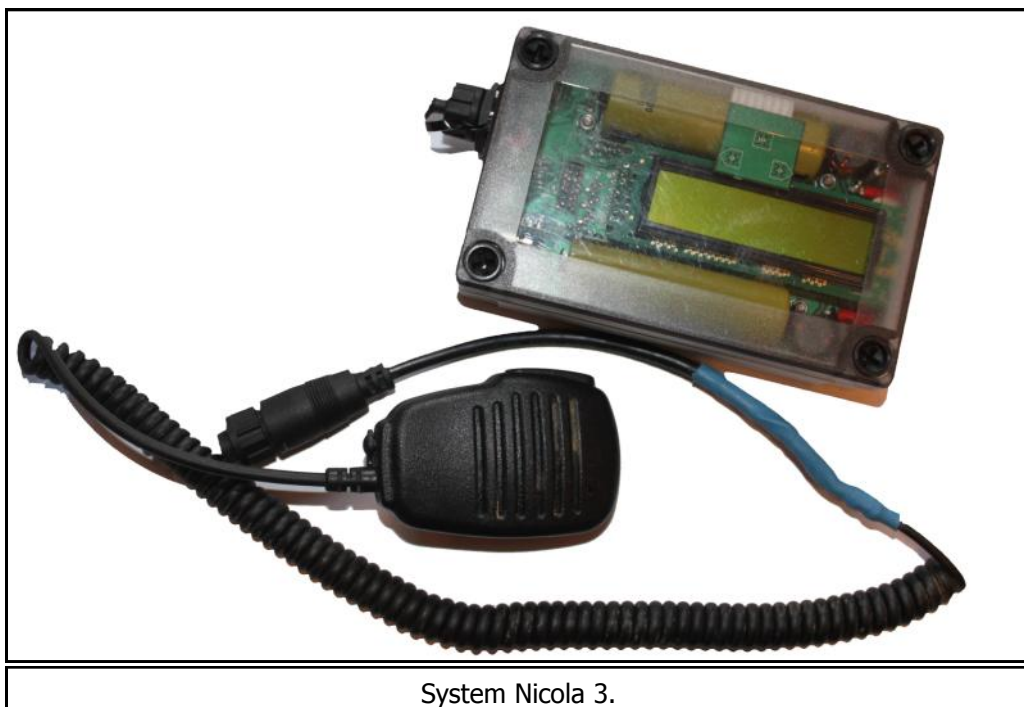

A H-bridge output stage to the antenna to drive it (and the resonant load presented by the earth antenna) in a Class DE mode (see simulations)

A simple buffer chip followed by an L-C low pass filter from the FPGA to drive a handset speaker with a Class D PWM output of the audio signal from the FPGA.

A simple battery management circuit organizes the power to the different parts from a pair of 18650 Li ion cells.

An LCD display connects directly to the FPGA as does the Bluetooth board and a simple capacitive touch PCB which allows user entry of menu options via the LCD.

The main signal filtering is then done digitally in the FPGA. This is the principle of so called software designed radio (though this is more precisely firmware defined radio).

The complexity of the design is then in the firmware and by using high level programming tools allows the design to be (in the jargon) abstracted away from the hardware allowing easy porting of the 'design' (AKA IP) to be ported to new FPGA hardware as the old hardware becomes obsolete.

The firmware design is performed using a toolbox called System Generator from Xilinx which works within Simulink (The Mathworks); this is a very powerful development environment for doing advanced signal processing, but sadly rather expensive unless you are an academic institution. The firmware includes 4 soft processors (called Picoblaze) that are very compact 8 bit processors for managing various functions (serial port, Bluetooth pairing, Keypad/LCD and real time processing of 8kHz audio data stream - e.g. Automatic Gain Control).

The design is now validated in field tests underground and a few remaining bugs are expected to be removed in a final production of 2 prototypes. If these prove successful, then production should begin towards the end of 2012. Please contact Pete Allwright if you wish to be part of the first production run. Though I would not want to discourage individual hobby builders, the PCB does still have some rather fine SMD components and production costs really do come down (and reliability improves) when made in batches, so group buying is to be recommended.

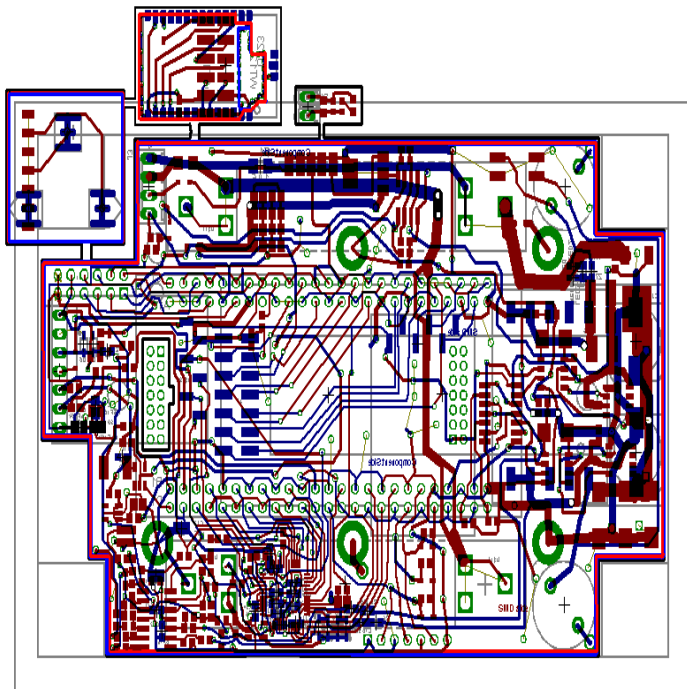

Nicola 3 PCB layout on 2 layers (note subsidiary boards for touch pads, Bluetooth and LED antenna tuning board).

One further issue of note that should be stressed is that the output stage (as mentioned above) is designed for a resonant load coupling the current into the ground via the capacitance of the antenna wires. The capacitance is increased by using multiple strands (see photo). The optimal tuned arrangement is determined by measuring the current in one strand with a pair of LEDs and a resistor in parallel at the bobbin end as it is wound out. I also show how the tuned impedance of the antenna varies with deployed length of the multi-strand section and also the height above the ground (see figures). One advantage of capacitive coupling of the antenna current into the ground is that it is sinusoidal even with a square wave drive, so reducing dramatically the harmonic emission. A second significant advantage is that with such a tuned antenna, about twice the current can be driven compared to a large well buried stake in soil with around 3 liters of water poured on it. This current gain is also achieved while improving the power efficiency compared to the Nicola 2.

Contacts for more information:

Graham Naylor: graham@grahamnaylor.net

Pete Allwright: peteallwright@btinternet.com



Signal generator connected to antenna wire through adjustable inductor box to determine resistive ground impedance (current maximum measured by Rogowski coil).

System Nicola Mk3 Cave Radio

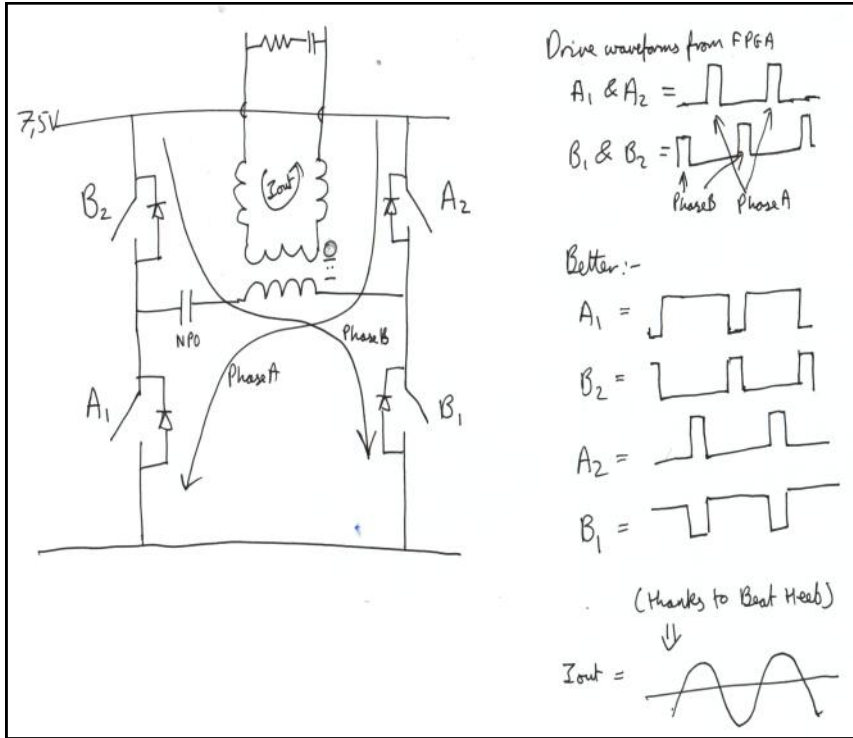

H-Bridge output stage driven around 87kHz allows very efficient driving of sinewave current into the ground

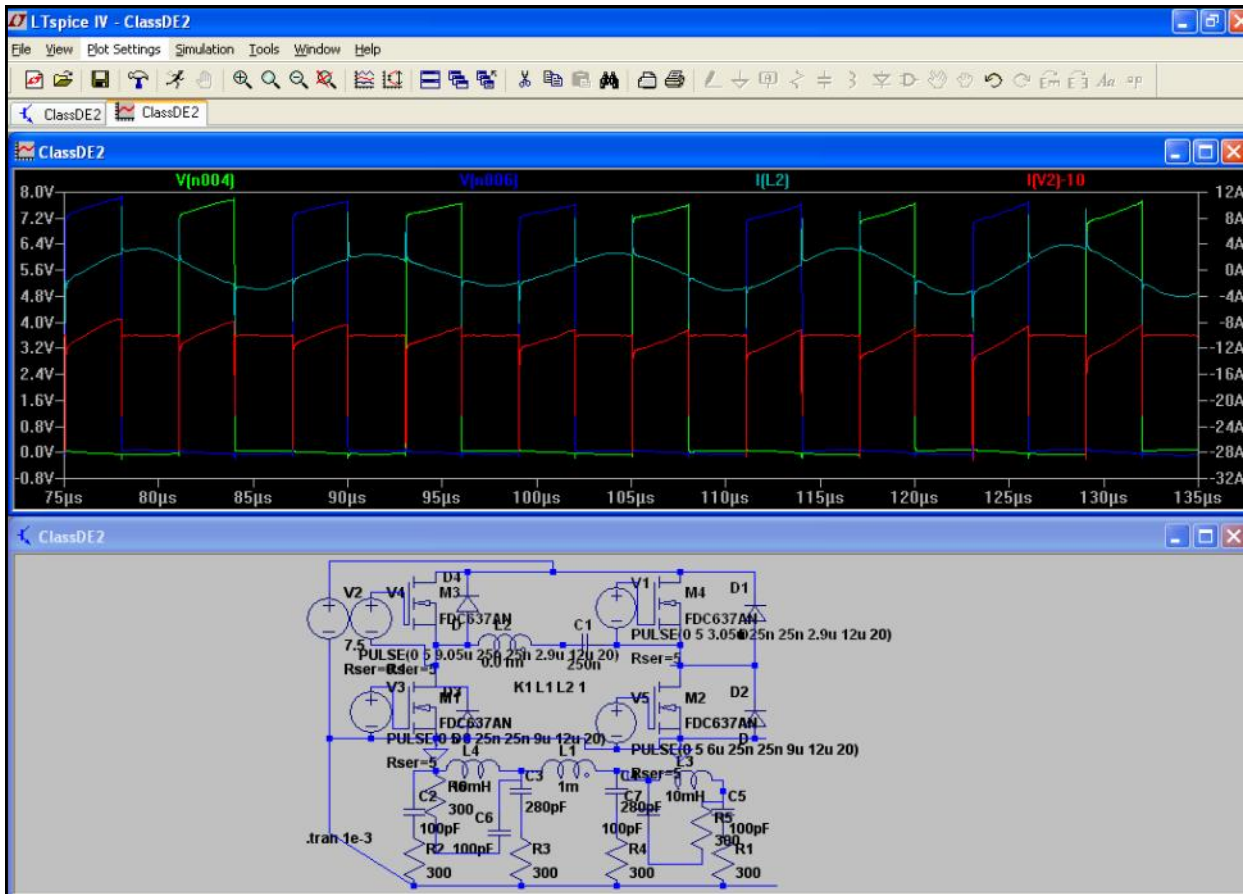

System Nicola Mk3 Cave Radio



Earth current antenna wires NOT connected to a ground stake - coupling achieved using capacitance of several strands at the end. Capacitance tuned to match a resonant inductor in the N3 box by adjusting length deployed and measuring current in one strand using LEDs mounted on the bobbin.

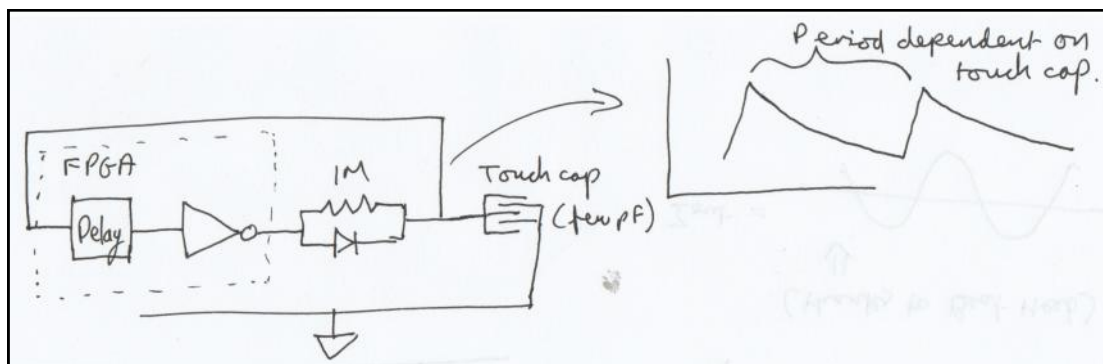

Simple capacitance 'touch' switch'. FPGA measures oscillation frequency and so presence of finger.

System Nicola Mk3 Cave Radio

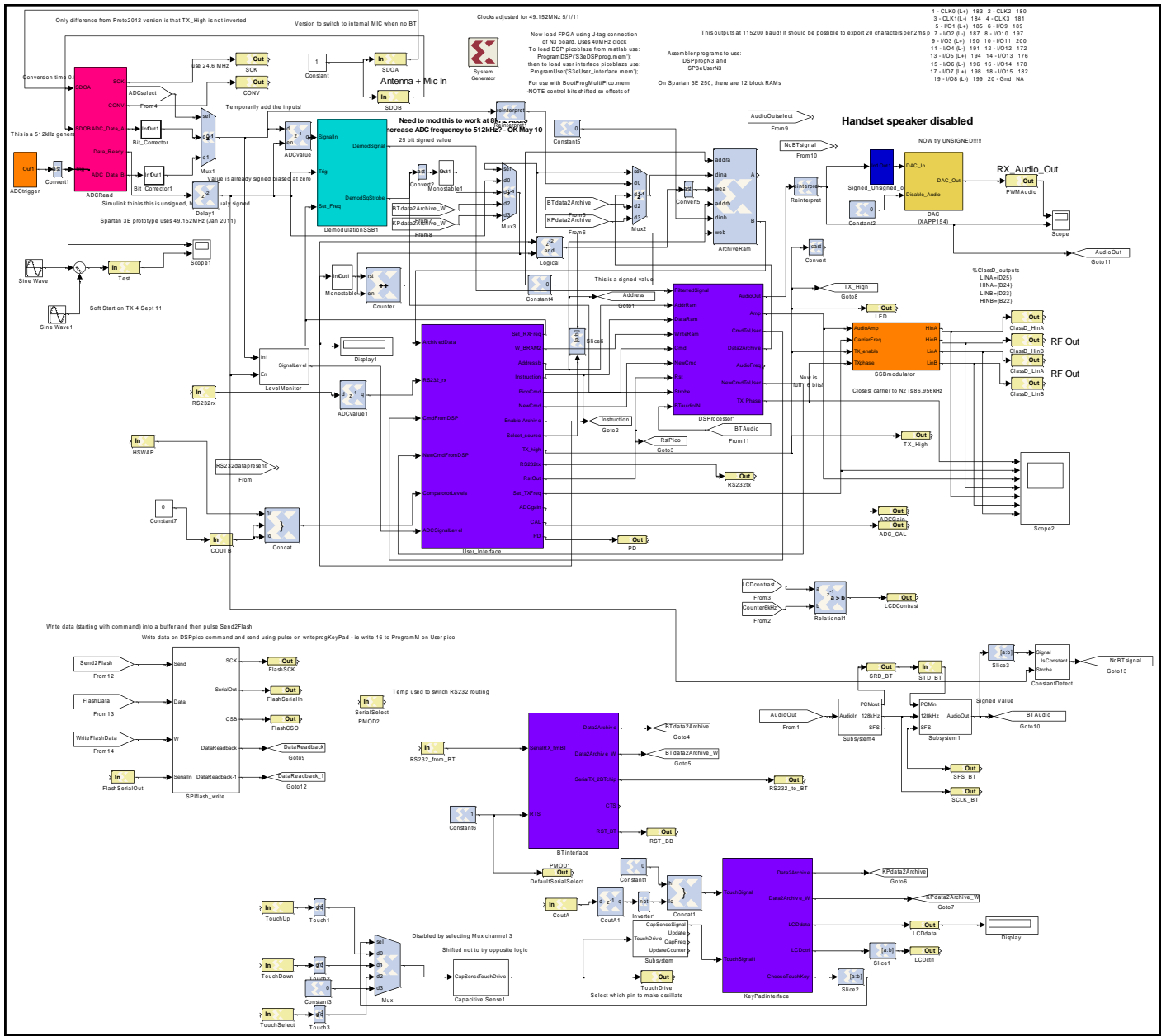

Firmware design developed in System Generator™.

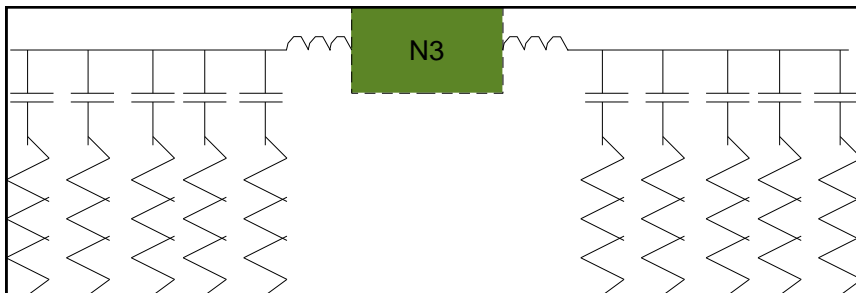

Model of antenna impedance with capacitive coupling to ground.

System Nicola Mk3 Cave Radio

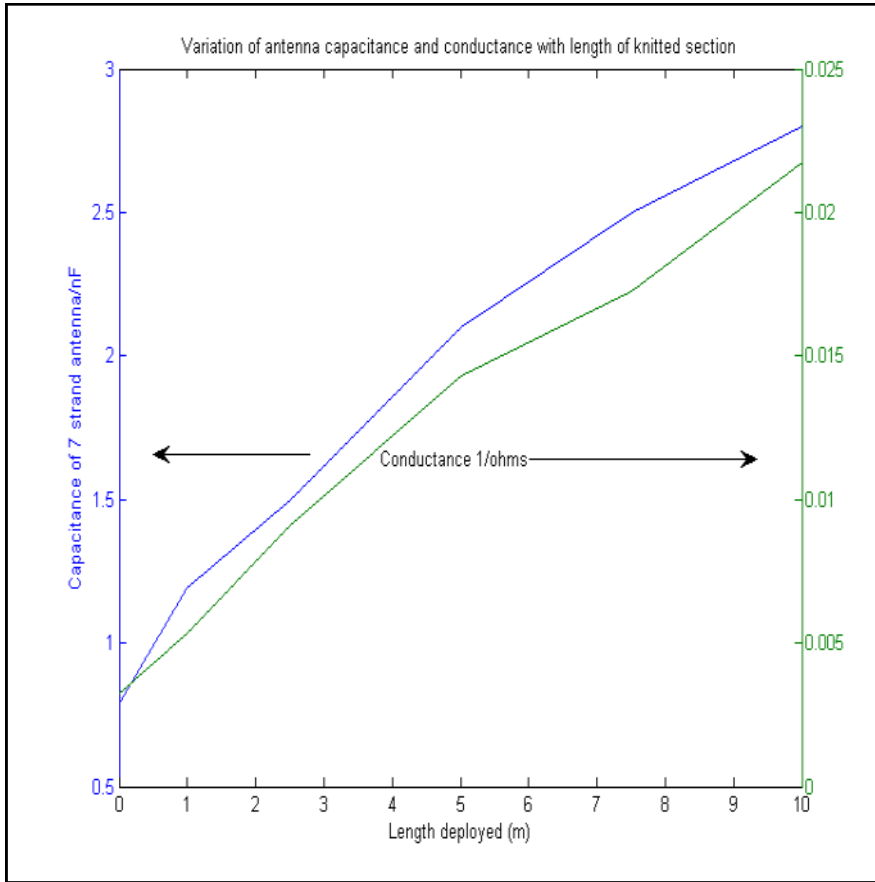

Variation of antenna capacitance and tuned impedance with length of multi-strand section deployed.

Variation of antenna capacitance and tuned antenna load impedance with reciprocal of the height of the wires above the ground.

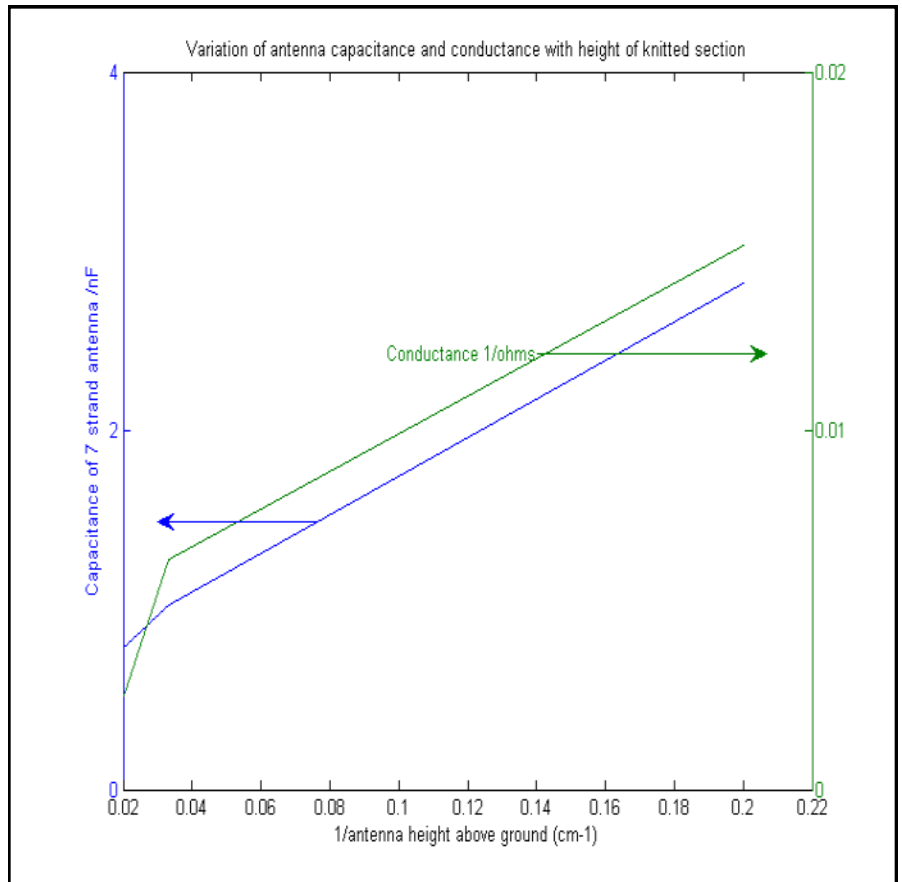

Photos of CES meetings and field trips during the NSS Conventions of 2009, 2010, 2011



Paul Jorgenson presenting at the 2009 NSS Conv. C&E Session (Jansen Cardy)

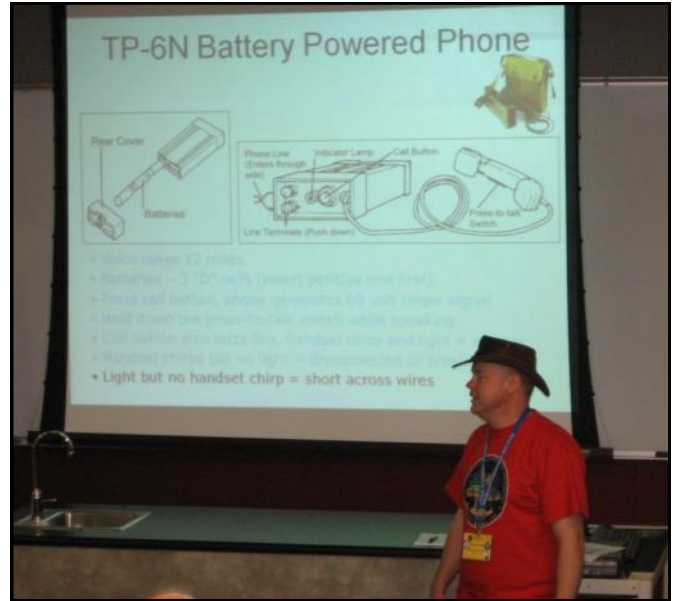

Jansen Cardy presenting at the 2009 NSS Conv. C&E Session (Norm Berg)



Brian Pease, John Lyles, and Paul Jorgenson demonstrate various gadgets at the 2009 NSS Conv. C&E Session (Jansen Cardy)



David Larson speaking to the members at the 2011 NSS Conv. C&E Session (Jansen Cardy)



Paul Jorgenson presenting at the 2011 NSS Conv.
C&E Session (Jansen Cardy)



2009 NSS Conv. C&E Session (Jansen Cardy)



Jansen Cardy Presenting at 2009
C&E Session (Norm Berg)



2011 NSS Conv. C&E Session (Jansen Cardy)



2010 NSS Conv. C&E Session (Jansen Cardy)



Searching for the null at the 2011 NSS Conv. C&E Field Session (Bill Franz)



Radiolocation equipment at the 2011 NSS Conv. C&E Field Session (Bill Franz)



Paul Jorgenson setting up 80M radio at the 2011 NSS Conv. C&E Field Session (Bill Franz)



Calculating the cave depth at the 2011 NSS Conv. C&E Field Session (Bill Franz)

Speleonics Table of Contents Issue #1 – #27

Most from: <http://www.caves.org/section/commelect/splnctoc.html>
(page number is in parenthesis)

Speleonics #1

Volume 1 #1 Spring 1985

Speleonics Premier Issue (1)
Editorial (1)
Section Logo (drawing) (1)
Calling all Cave Radios (2)
QST (2)
Magnetic Moments (3)
Radio Communications in Ape Cave, Wash (5)
Emergency Lightbulb Repair (6)
Organ Cave System Radio (7)
A Telephone to Radio Repeater for Cave Rescue (7)

Speleonics #2

Volume 1 #2 Summer 1985

Editorial (1)
Needed: A working Cave Radio (1)
Report on Cave Communication and Electronics Section Meeting (2)
Magnetic Moments #2 (4)
Cave Communications Bibliography (7)
Thoughts towards designing an "International" Cave Radio: Choosing an operating frequency. (9)
Communications Standard #1 12 volt DC power (11)

Speleonics #3

Volume 1 #3 Fall 1985

Cave Radio Ethics: Artificial Entrances (editorial) (1)
Slug Tuned Coil (cartoon) (1) Organ Cave Radio (2)
Organ Cave Trip Report (3)
Cave Rescue Communications: Linked Systems
· Part 1 (6)
· Part 2 (7)
Magnetic Moments #3 (9)
Ricky Resistor (cartoon) (10)

Speleonics #4

Volume 1 #4 Spring 1986

Entranceless Caves (editorial) (1)
Corrections to Organ Cave Radio (1)
Letters (1)
Simple Circuit for Automatic Second Bulb (3)
The Unique Self Climbing Ladder (4)
Some Thoughts on Cave Radio Antenna Design (6)
High Power on 160-189 kHz? (7)
Radios Save Caves (7)
Cave to Surface Communications (8)
How to Make an Ultrasonic Rangefinder (10)
Caving with the Polaroid Ultrasonic Rangefinder (10)
Inexpensive 2.5 MHz WWV Receiver (11)
Membership List (12)
Late Section News (12)
The Michie Phone System (13)
Cartoon (14)
Input Wanted (14)

Speleonics #5

Volume 2 #1 Summer 1986

Editorial (1)
Letters (1)
Announcements (2)
Circuit Description, Alberta Speleological Society Cave Radio (3)
LED Survey Target from Modified Flashlight Bulb (10)
Welcome New Members (10)
Bibliography Supplement (11)
LORAN C for Cavers (12)
Cartoon (13)
Notice to Subscribers (13)

Speleonics #6

Volume 2 #2 Fall 1986

Editorial (1)
Announcements (1)
Letters (1)
Nuclear Flashlights! (2)
Flashlight Maintenance (3)

The Firefly Lamp (4)
Electric Caving Before Lightbulbs or Carbide (6)
Help Needed: Recharging Batteries Underground (7)
Mine Lamp Charger (8)
Magnetic Moments #4: Ferrite Core Antennas (10)
Resources (11)
New Products (12)
Late News (12)
The Cave Assault Tube (13)
Light source Launcher (13)
Lighting Up Your Suunto (14)
Abstracts (15)
Cartoons (9) (15)

Speleonics #7

Volume 2 #3 Spring 1987

Announcements (1)
Letters (2) (3)
Emergency Watch Repair for Cavers (3)
Where the Sun Sometimes Shines: Solar Power at a Cave Research Field Station (4)
Cave Radio M-85 (8)
Magnetic Moments #5: The Phase Problem (11)
QRP Transmitting and Receiving on 800-1000 Hz (305,000 meters!) (13)
Resources (14)
Radon Monitoring in Caves (15)
Radon Sampling in the Mammoth Cave System (16)
The Ogofone (16)
NPS Radio Freqs (16)
Phone Patch Connects Cave to Hospitals (17)
Cave Rescue Communications Equipment Checklist (18)
Bat Power Patch (1)
BNC (Big Name Caver) (3)

Speleonics #8

Volume 2 #4 Summer 1987

Editorial (1)
1987 NSS Convention Electronics Session Report (1)
Letters (2)
Partial List of Past and Present Cave Radio Frequencies (3)
DECCA Navigation System Information (3)
British "Molefone" Voice Transceivers Tested at U.S. Cave Rescue Seminar (4)
A Short Bibliography of Electric Cave Lighting (6)
The PBR Flash Gun (9)
Long Range Cave Radio (10)
Magnetic Moments #6: The Transition Zone (13)
Abstracts (14)
Resources (14)
Cartoon (15)
Hunting for Dinosaur with Radar (15)

Speleonics #9

Volume 3 #1 Winter-Spring 1987-88

Just for Fun (1)
News and Announcements (2)
Letters (4)
Sensitive Slave Flash for Cave Photography (5)
Recent Developments in Superconductivity Research (6)
A Cave Radio in the Field - Summer 1987 (7)
Magnetic Moments #7: Electromagnetic Noise - Natural Sources of Noise (9)
Battery Date Codes (11)
Morse Code Aptitude Test (11)
Resources (11)
The Mini Maglite(tm) and Variants: Electrical Tests and Caver Modifications (12)
In Review (13)
Frequencies of Interest: 1988 NSS Convention (13)
Electronic Wristwatch makes Emergency Flashlight (14)

Speleonics #10

Volume 3 #2 June 1988

News and Announcements (1)
Letters (3)
Cave Rescue Communications Security (4)
Early Radio Experiments in Caves (5)
Will Electronic Compasses "Automate" Cave Mapping? (9)
Resources (10)
Electronic Caver Detectors (11)
Abstracts (11)
Publication Reviews (12) (14)
The Easiest Cave Radio: Extending The Range of Avalanche Beacons (13)

Cave Air Flow Detection (15)
New Low Frequency Newsletter (15)

Speleonics #11

Volume 3 #3 November 1988

Editorial (1)
News & Announcements (1) (2)
Letters (2)
Hruska's Wheel Antenna (3)
The Mendip rescue Organization (MRO) Antenna (4)
ASS Giant Antenna (4)
Receiving Cave Radio Signals With a Whip Antenna (5)
Magnetic Moments #8: Antenna Noise (6)
Coil Winding Machines (6)
Resources (7) (8)
Brian Austin Letter to "New Scientist" (8)
Monitoring Magnetic Declination (9)
Electric Drilling Hammers For Caving (10)
Reviews (12)
The Global Positioning System (GPS) (13)
The Atomic Adventure of Dennis Drain (13)

Speleonics #12

Volume 3 #4 April 1989

There is No Nobel Prize for Speleology (cover)
Editorial (1)
News & Announcements (1)
Australian Rescue uses Cave Radio (2)
Letters (3) (8)
Magnetic Moments #9: Ground Conductivity by Electromagnetic Methods (4)
Scientific Cave Location (6)
Capacities of Primary Cells (9)
Summary of the Cave Rescue Telephone Project (10)
Photos of Luminescent Cave Minerals Wanted (13)
Resources: Ultraviolet Lamps for Mineralogy (14)
Japanese Cave Radio used in World War II (15)
Reviews (15)
Electronic Bat Feeder (cartoon) (14)
Art by Jay Jorden (15)

Speleonics #13

Volume 4 #1 October 1989

Letters (1)
News & Announcements (2) (8)
Piezoelectric Ignition for Carbide Lamps (3)
Field Expedient VHF Direction Finder (6)
GPS Update (6)
I Built an Ultrasonic Receiver (7)
Batradio (7)
New Products (9) (10)
Resources (10)
The Geomagnetic Storm of 13 March 1989 (11)
Low Noise ELF (ULF Range) E-Field Preamplifier (12)
Experimental Heart Tachometer (13)
Altimeters for Cavers (14)
Art:
· Earth-Air-Fire-Water-Caves (11)
· ASCII Bat (8)
Calcium Cell (back cover)

Speleonics #14

Volume 4 #2 February 1990

Editorial (1)
News and Announcements (2)
Letter (2)
Cave Camera Explodes (3)
Home Brew v. Commercial Equipment Test (4)
Sound System Aids Recovery of Worlds Largest Dinosaur (4)
Doolin Green Holes from the Surface (4)
CB Radio for Underground Communication (5)
Electronics in Action (6)
The 1967 Ingleborough field Meet Report: Induction Communications Systems in Caves (7)
James R. Wait - Senior Theorist of Cave Radio (8)
Impulse Radar Technology may yield "Cave Scope" (8)
Bat Phone (9)
Book Review (9)
More on Altimeters for Cavers (10)
Casio Altimeter Watch Notes (10)
Interesting References (10)

Magnetometer Notes (11)
Recording Jam Jar Magnetometer (11)
Radionavigation System Developments (12)

Speleonics #15

Volume 4 #3 October 1990

Editorial (1)
News and Announcements (1)
Letters (2)
Resources and New Products (2)
Atomic Strobes and Other Exploding Things (3)
Mapping Caves Magnetically (4)
Voices From the Past (5)
Great Moments in Early Cave Radio Experiments (6)
1990 NSS Convention Electronics Session (6)
Self Potential Surveys (7)
Bibliography Supplement (8)
French Electric Mine Lamp Used in 1869 (9)
Interesting References (9)
The Wet Noodle Field Phone (10)
Charging Sealed Lead Acid Batteries (13)
Cartoon (13)
Update on Induction Cave Radio (14)
New Super High Brightness LED's (14)
False Center Found in Unusual Radiolocation (15)

Speleonics #16

Volume 4 #4 May 1991

News and Announcements (1)
1991 NSS Convention Electronics Abstracts (2)
Wheat(tm) Lamp Notes (2)
The Stanley Estimator and Other Miscellaneous Ramblings (3)
Measuring Ground Conductivity with a Cave Radio (4)
Rockwell GPS Receiver (6)
Cavers Get Hands On Experience with GPS Navigation (7)
Resources, References, New Products (8)
Early Advances in Underground Radio Communication (9)
Rejuvenating Sealed Lead Acid Cells (12)
Earth Dipole Communication Notes (12)
Phone Patch for Handheld Radios (13)

Speleonics #17

Volume 5 #1 April 1992

News and Announcements (1)
Kartchner Caverns Cave Meteorology System (2)
The Use of Data Loggers in Cave Science (5)
Wet Noodle Passes Field Test (7)
Photoelectric Caver Counter (8)
Fluorescent Lights for Caving? (9)
Maglite(tm) Flashlight Field Repair (10)
A Peculiar Battery Problem (10)
British Cave Research Association Cave Radio and Electronics Group (10)
BCRA Publishes Easily Built Cave Radio (11)
1991 Cave Rescue Communications Notes (11)
Electronic Thermometers Tested at Practice Cave Rescues (11)
Instant Cave Phone (12)
TA-1/PT Sound Powered Telephone Notes (12)
Resources and Interesting References (13)

Speleonics #18

Volume 5 #2 July 1992

Letter (1)
Announcement (1)
Alkaline Primary Cell Failure Mode (2)
Incandescent Lamp Parameter Variation with Voltage (2)
Switching Voltage Regulators for Lead Acid Battery Chargers (3)
H2 Catalysis for Sealed Strobes (5)
More on High Brightness LED's (6)
Amber LED Notes (9)
A Cheap and Portable Homemade Ultraviolet Lamp (10)
Resources and Interesting References (11)
Piezoelectric Sound Powered Telephone (11)
Characteristics of Bulbs Used in Mini Maglite(tm) Flashlights (12)
Radio Frequencies of Interest to Cavers (USA) (12)
Flashlight Surgery (12)

Speleonics #19

Volume 5 #3 May 1993

Editorial (1)
Letters (1)

Erratum (1)
News, Announcements, Resources (2)
Converting CB Radios for Use As Low Frequency Cave Radios (3)
Further Developments With The CB Transverters (9)
Quartz Halogen Cave Light (10)
Electric Caver Heater versus Chemical Heat Packs (10)
Amplifier Handset Enhances Cave Rescue Telephone (10)
Piezoelectric Sound Powered Phone Improved (11)
Wheat Lamp(tm) Charger Notes (12)
Cartoon (12)

Speleonics #20

Volume 5 #4 February 1994

Editorial (1)
Announcements (1)
Update on the CB Transverters for Cave Radio Use (2)
Cave Radios and The Law (3)
NSS Convention Report - 1993 (6)
Amateur Radio 160 M Challenge (7)
Book Review: "The Electromagnetics Problem Solver" (7)
Resources (7)
Magnetic Moments #10: A Probe to Measure RF Magnetic Fields and the Magnetic Moment of a Transmitting Loop (8)
Pulse Width Modulated Voltage Regulator for Electric Caving Lamps (9)
Caver Rescue Communications Notes 1993 (14)
Color Code Mnemonics (15)
Interesting References (15)

Speleonics #21

Volume 6 #1 March 1997

Call For Papers (1)
Annual Cavers Meeting at Dayton Hamvention (1)
Speleotardiness (1)
Radio Crosslink Experiments (2)
Resonant Speaker References (2)
Historic Earth Dipole Communications (3)
Repair your Mini Maglite Flashlights (6)
Foot Candles (6)
Rechargeable Alkaline Cells (7)
Alkaline Primary Cell Failure Mode Update (9)
The D-Q Beacon Receiver (10)
Wideband Portable Antenna (20)
NiCd Memory Effect Explained (20)
Update on High Brightness LEDs (20)

Speleonics #22

Volume 6 #2 September 2001

Logo (1)
Information (1)
Section Officers (1)
Table of Contents (2)
Editorial (2)
Theory and Designs for Building a White LED Headlamp (3)
Firefly 2 Modification (7)
Light Bulbs for Caving Headlamps in the 21st Century (8)
Constructing a Linear Constant Current Dimmer for a White 24-LED Array (11)
Simple Current Limiting for LED Flashlights (14)
Equipment Review: Leica Disto classic3 Laser Distance Meter (15)
Build a Simple Bat Detector (16)
A Bat Simulator for Testing Bat Detectors (19)
GMRS and FRS Radio (20)
Another Gizmo I Can't Do Without (20)
LED Caving Lamp Development and Use (21)
Remote Cave Cameras (23)
Not Another LED Headlamp Miracle (24)
Message from the Chairman (25)
Minutes of the 2001 Communications and Electronics Section Meeting (25)

Speleonics #23

Volume 6 #3 August 2002

Logos (1)
Information (1)
Table of Contents (2)
Editorial (2)
Constitution (3)
Bylaws (4)
Section Officers 2002 - 2003 (6)
Yet Another Sensitive Slave for Flash Photography (7)
Camera Flash Adapter (10)
Endless Rope Climbing System with Dynamic Speed Control (13)

Water Tracing Experiments in Belize Using an Inexpensive Total Dissolved Solids Meter (15)
Cheap Field Telephone (20)
Minutes of the 2002 Annual Meeting (21)

Speleonics #24

Volume 6 #4 August 2004

Information (1)
Table of Contents (1)
Creating a Simple Regulated NiCd Cell Charger (2)
Minutes of the 2003 Annual Meeting (4)
An Improved High Power 2496 KHz Radiolocation Beacon (5)
185 KHz Radiolocation and 7 MHz Communication Experiments (8)
Beacon Controller, Cave Radio, Remote, DTMF Programming (9)
Can You Patent an LED Flashlight? (10)
Thru-The-Earth 2-Way Voice Communication With Cave Divers (12)
LED Flashlight White Paper (16)
Automatic Dark Detector Emergency Light (21)
Salvaging Throw Away Flash Cameras (22)
Computer Modeling Thru-The-Earth Communications Antennas (23)

Speleonics #25

Volume 7 #1 June 2005

Information (1)
Table of Contents (1)
A Firefly for Digital Cameras (2)
Minutes of the 2003 Annual Meeting (4)
Optimizing Circuits Using Computer Simulation (7)
Princeton Tec Yukon HL Hybrid + Headlamp (15)
A Luxeon LED for the Petzl MYO6 (20)
80 Meter HF Radio Experiments (25)

Speleonics #26

Volume 7 #2 July 2007

Title, Table of Contents (1)
A Radiolocation Device for Cavers (2)
Review of the New Leica Disto (7)
Homebrew Earth Resistivity Meter (9)
AC Mains Timed Output Controller (13)
Lithium 123 Cells with Caving Headlamps (14)
An HF Portable Antenna (17)
Homebuilt HF Radios for Use Underground (19)
HF Radio at Grand Canyon Caverns (24)
2005 NSS Convention Minutes and Notes
2006 NSS Convention Minutes and Notes
Editor Notes

Speleonics #27

Volume 7 #3 June 2011

Title, Table of Contents (1)
Frank Reid Remembered (2)
Radio Slave for Flash (5)
185 KHz Ferrite Core Antenna (6)
Radio Propagation Testing in Lava Tubes (8)
Carlsbad Caverns Radio Caving (10)
Very High Power Radiobeacon (15)
The TP-6N Field Telephone (24)
Simple Phone Line Amplifier (26)
Modifying the Classic Phone Patch (27)
C&E Minutes 2007 and Langdon's Cave Field Day Photos (28)
C&E Minutes 2008 (30)
C&E Minutes 2009 (31)
C&E Minutes 2010 (32)
C&E Session 2010 (33)
Fun Graphics and Editor Notes (34)