

speleonics 11

NOV.
1988

"BETTER CAVING THROUGH ELECTRICAL STUFF"

volume III number 3



CONTENTS

Editorial
 Ian Drummond 1

NEWS & ANNOUNCEMENTS -
 First BCRA Electronics Newsletter
 1988 NSS Convention report
 Biologists to use cave radio
 Autohelm™ compass gets bad review
 New Wind Cave map corrected for radio survey
 Cave radio at Jewel Cave expedition 1, 2

LETTERS -
 Duke McMullan
 Dave Johnson 2

HRUSKA'S WHEEL ANTENNA
 Joe Hruska 3

THE MENDIP RESCUE ORGANIZATION (MRO) ANTENNA
 Brian Prewer 4

ASS GIANT ANTENNA
 Ian Drummond 4

RECEIVING CAVE-RADIO SIGNALS WITH A WHIP ANTENNA
 Ian Drummond 5

Magnetic moments #8: ANTENNA NOISE
 Ian Drummond 6

COIL-WINDING MACHINES
 Frank Reid 6

RESOURCES -
 Digitemp(™) Battery Tester
 Burhans Electronics
 Ultrasonic Bat-Detector [BCI]
 Portasol(™) soldering iron / torch
 Mouser Electronics 7, 8

Brian Austin Letter to New Scientist (reprint) . 8

MONITORING MAGNETIC DECLINATION
 (Combined reprints) 9

ELECTRIC DRILLING-HAMMERS FOR CAVING
 Peter Ludwig 10

Reviews:
 VLF receivers [E. Paschal]
 1750m antennas [M. Mideke (ed)]
 EPA geophysical techniques
 ELF Transmitter [Popular Communications]
 Earth-return cave phone [BCRA] 12

THE GLOBAL POSITIONING SYSTEM (GPS)
 D. McClintock 13

Humor (reprint) -
THE ATOMIC ADVENTURE OF DENNIS DRAIN 13

SPELEONICS is published approximately four times per year by the Communication and Electronics Section of the National Speleological Society (NSS). Primary interests include cave radio, underground communication and instrumentation, cave-rescue communications, cave lighting, and cave-related applications of amateur radio. NSS membership is encouraged but not required.

Section membership, which includes four issues of **SPELEONICS**, is \$4.00 in USA/Canada/Mexico, \$6.00 overseas. Send subscriptions to section treasurer **Joe Giddens** at the address below (make checks payable to **SPELEONICS**). If you have a ham-radio callsign or NSS membership number, please include them when subscribing.

Foreign subscriptions can be paid in U.S. "paper" dollars in the mail; an international money-order may cost as much as the subscription. Many members have sent cash without problems. (No foreign currency, please.)

Editorship rotates among the officers. Volunteers are encouraged to guest-edit or produce an issue. A technical session, followed by election of officers, is an annual event held during the NSS Convention.

Complimentary copies of **SPELEONICS** are mailed to NSS offices and sections, the U.S. Bureau of Mines, U.S. Geological Survey, and the Longwave Club of America.

Chairman (and editor of this issue):

Ian Drummond
 5619 Dalwood Way NW
 Calgary, Alberta
 CANADA T3A 1S6

Treasurer (and editor of issue #13):

Joe Giddens NS1OZ
 PO Box 891
 Camden, Arkansas
 71701
 [New Address]

Secretary (and editor of issue #12):

Frank Reid W9HKV
 P.O. Box 5283
 Bloomington, Indiana
 47407-5283

Publisher:

Diana E. George N9DEJ
 1869 Trevilian Way
 Louisville, Kentucky
 40205

----- COVER -----

Linda Neslop's drawing of Ian Drummond with 115-kHz voice SSB cave radio, during tests at Jewel Cave, 1988. Linda's cave art has often appeared in the NSS News. See **SPELEONICS 5** for description of Ian's equipment.

The "ultimate cave-rescue vehicle" pictured on last issue's cover has been identified as a LAV (Light Armored Vehicle) made by General Motors, in electronic-warfare configuration.

Editorial

The skill with which a cave line-survey has been performed is frequently judged by the closure error of loops within the survey.

The advent of cave radio locations at many caves is providing a more stringent test, as it is now possible to relate the cave survey closely to ground features and hence to the topographic map of the area. When reading a compass, it is not adequate that the readings be repeatable, or have high precision; they must also be accurate.

Accuracy requires not only skilled operators and correctly adjusted compasses, but a knowledge of the local magnetic declination. In short it is advisable that the compass be calibrated near to where the survey is being performed. In this issue two approaches to this problem are explored. One solution uses the latest satellite technology, the Global Positioning System; the other uses a centuries-old method. Both have the potential to help produce more accurate cave maps.

--Ian Drummond

NEWS AND ANNOUNCEMENTS

BCRA ELECTRONICS NEWSLETTER RECEIVED

Congratulations to the **British Cave Research Association Cave Radio and Electronics Group** upon publication of their first newsletter! The 13-page Autumn, 1988 issue includes plans for a voice cave radio, Hall-effect magnetometer, photoflash slave unit, and several other articles.

BCRA CREG has shared with us their computerized cave-electronics bibliography, which uses PAPER-BASE, a very easy-to-use database program designed especially for bibliographies, which stores references as ordinary ASCII files.

The quarterly newsletter cost 2 Pounds Sterling (about \$6) for four issues. For more information, contact:

Phil Ingham 66HDD
BCRA Radio Group
49 Highfield Road
Farnworth
Bolton BL4 0AH
UNITED KINGDOM
--

1988 NSS CONVENTION REPORT

Approximately 45 people attended our fourth annual Electronics Session. Three papers were presented (see abstracts in SPELEONICS 10).

Dave Larson demonstrated the Autohelm^(tm) electronic fluxgate compass. Dave also demonstrated a pair of single-wire cave telephones which he acquired in New Zealand (see SPELEONICS 4).

Gary Taylor spoke about Gates Cyclon cells, an advanced form of "gel cells" which have superior qualities making them especially attractive for caving applications.

Duke McMullan demonstrated an inexpensive ultrasonic rangefinder, and presented the circuit used in his hardhat covered with blinking LED's: An LED with internal blinker circuit will blink additional LED's in series-- Duke's hat has a 9-volt battery connected to eight parallel sets of three various-colored LED's in series, with one blinking LED in each series string.

Jim Basinger showed cave radios of Ray Cole's design (SPELEONICS 3) which were professionally built for Jewel Cave National Monument, but were not yet in working order.

Don Lancaster spoke about new and inexpensive electronic components applicable to cave instrumentation: Pressure transducers, LVDT interface chips, floating-point A/D converters, IC accelerometers, and the M50734 CMOS microprocessor. See Don's "Hardware Hacker" column in Radio Electronics magazine, August 1988, p. 69. Don also demonstrated the engineering and graphic powers of

POSTSCRIPT software, which is especially interesting to newsletter editors.

Max Carter spoke about Binary Phase-Shift Keying, a data-transmission method with which he has sent low-speed ASCII data for more than 1000 miles, using a one-watt transmitter and 50-foot antenna on the 1750-meter band (see Max's article in The Lowdown, July 1988, p. 18, which references his previous articles.

The membership voted to grant **Ian Drummond's** request for \$200 for editing video tape recorded at Castleguard Cave, demonstrating cave radio. All incumbent Section officers were re-elected.

--

BIOLOGISTS TO USE CAVE RADIO

At the NSS Convention, two biologists requested cave-radio information; they intend to use cave radio in Hawaiian lava-tube caves, to identify individual trees whose roots penetrate the passages. The caves are only about 25 feet deep; they may be able to use the enhanced avalanche-beacon configuration described in SPELEONICS 10.

--

AUTONELMtm ELECTRONIC COMPASS GETS BAD REVIEW

Roger Bartholomew presented test results of an Autohelm in his paper at the NSS Convention cartography session, in which he concluded that the Autohelm is unsuitable for cave survey because of its sensitivity to tilt-- 0.4 degree of pitch or roll yields a one-degree azimuth error. More sophisticated fluxgate compass sensors have magnetic cores which float in a dense liquid; these are claimed to be self-levelling up to 5 degrees of tilt. See **Don Lancaster's** "Hardware Hacker" column in Radio Electronics magazine, December 1988, p. 33 for a discussion of the fluxgate's operating principle, a circuit for experimenting, and other information of interest to cavers.

--

NEW MAP OF WIND CAVE CORRECTED FOR RADIO SURVEY

A multitude of rangers and cavers at Wind Cave National Park have been instrumental in publishing a new map of the cave, showing 51 miles (82 km) of passage. The old map sold at the visitor center shows 46 miles (74km). The new map was produced with the aid of computer programs SMAPS and AutoCad, and contains 25 radiolocations as constrained points for loop-closure purposes. The new map is available from the Wind Cave Natural History Society, Wind Cave National Park, Hot Springs, South Dakota 57747, for \$6.00.

--

CAVE RADIO AT JEWEL CAVE EXPEDITION

Paul Wightman and Frank Reid brought cave radio equipment to the Northwest Cave Research Institute (NCRI) expedition at Jewel Cave National Monument, South Dakota, the week after the NSS Convention. Fifteen cave-radio locations were done at depths to 360 ft (110m). NCRI plans a total of 75 radio-locations in the 76-mile (122km) cave system, in a project spanning the next two years. The radio-locations will be used for map calibration, similar to the method used at Wind Cave.

Interference from surface power lines made some radiolocations unusable; NCRI will prepare a power-line map to help plan future cave-radio operations. Summer atmospheric noise was tolerable before noon but became intense with afternoon buildups of cumulonimbus clouds over the Black Hills.

Surface-to-cave signalling told underground parties when data gathering was complete, saving appreciable time on trips where multiple radio-locations were made.

Ian Drummond and Frank Reid compared the performance of 114 kHz and 3.5-kHz cave radios at Jewel Cave, where strong directional anomalies were encountered at both frequencies near the elevator shaft and a steel-lined horizontal artificial tunnel. The tests were incomplete because Frank's transmitter failed. A new transistor from a local TV shop repaired it in time for the expedition. No anomalies were encountered away from the "improved" areas of the cave.

Several cavers who used cave radio for the first time at Jewel Cave plan to build innovative designs of their own. We anxiously await their results!

----- LETTERS -----

Dear Frank,

WAY back in Speleonic 2, The Communications Standard #1.0 of the Eastern Region of the National Cave Rescue Commission was (re)published. This was the "standard" two-pin Jones plug, available at Radio Shack, et al, set up with the wide prong negative and the narrow prong positive for general-purpose power supply connections for a variety of 12VDC equipment. It so happened that SAR folks in New Mexico have been using those plugs for a number of years, but with the wide prong positive. This presented a mild quandry, as I wasn't about to redo my entire setup (since I'm more likely to need them out here (West) rather than back there (East), yet I might easily encounter the other polarity of plug.

A voltmeter with a plug would tell me what I had, but it's a little awkward to drag around. Here's what I finally came up with:

Take one of the male inline plugs (RS 274-201 or eqv.), gut it, remove the cable clamps, and solder to the terminals a 330 ohm resistor and a "bipolar" (tricolor) LED, RS 276-012 or equivalent. This is the type with TWO leads -- not three. Set it up so that when it is plugged into the polarity that's proper for YOUR equipment, the LED glows green, and when the polarity is wrong for YOUR equipment, it glows red.

Mount the components so the shell will fit over the resistor and LED, with the LED sticking partly out the hole. Solder. Place the shell over the components. Test again. Make SURE it's working properly. Pot the components in epoxy, silicone

sealant, Shoe Goo II or cave mud. Enjoy.

It takes only a moment to insure that a plug has the right polarity: Correct, it glows green; incorrect, it glows red; AC, it glows yellow; nada, it doesn't glow; 800V, it makes a bright flash, a loud pop and a bad smell.

Actually, a dedicated voltmeter with a male Jones plug is nice to have around to keep an eye on the system voltage: it'll tell you when you need to run your engine for a little while. If you're feeling ambitious, the meter box could have additional circuitry to beep at you if the battery gets too low. QUESTION: What is the appropriate trigger voltage?

Unnecessary caution: Always put FEMALE plugs on your power SOURCES. ALWAYS.

Duke McMullan N5GAX NSS 13429R
Sandia Grotto
e-mail: ee5001ae@charon.unm.edu

--

Dear Frank,

I was at the Lowfer Convention and had a ball. I built a little direct-conversion Lowfer-band receiver a little bigger than a pack of cigarettes... It worked really good, especially on a Burhans active whip which Mitch Lee loaned me... Made a potentially useful discovery-- my beacon, which is FSK'd, can be heard through the noise much more clearly than if it were straight keyed carrier. That tone shift just makes it pop right out of the noise. According to my "earball" calibration, it's probably worth a good 10 dB in copyability.

I have an idea on measuring depth on a VLF induction "radio." If the transmitter output is regulated precisely, then depth can be measured indirectly by measuring field strength, without the need for triangulation techniques. However, you do have to be over the top of the transmitter or in some known geometric relationship to it. Will underground formations alter field strength enough to screw up the depth measurement? I believe not, but I don't know for sure.

Dave Johnson
713 Texas Ave.
Los Banos, CA 93635

--

Dave Johnson is a 1750m experimenter and designer of metal detectors. He writes a regular column about radio below 10 kHz in Herb Balfour's Northern Observer newsletter (see Speleonic 10, p.15).

APOLOGY: Part of Dave Johnson's letter, and some other letters, were misplaced and could not be found at publication time. --Frank Reid

--

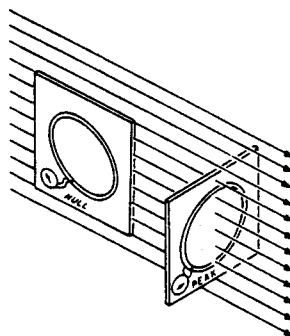

HRUSKA'S WHEEL ANTENNA

by Joe "The Mole" Hruska (NSS 20253)

Here are details of the "wheel" antenna that I displayed at the 1986 NSS Convention.

Operating frequency	3580 Hz.
Overall diameter	0.419m 16.5"
Coil diameter	0.406 16.0
coil height	0.025 1.0
coil thickness	0.006 0.25

Construction materials :

- 1 nylon BMX-bicycle-style wheel minus metal parts
- 2 plexiglas(tm) disks to cover axle holes
- 1 bubble-level mounted inside axle hole on plexiglas disk
- 10 brass screws to attach plexiglas disks
- 1 plexiglas cutout to mount between the spokes
- 3 brass nuts, bolts and washers for mounting cutout
- 1 Radio Shack project box used as junction box
- 4 brass screws to replace junction box steel screws
- 2 brass bolts, nuts, and wingnuts to connect to primary
- 1 0.039uF 500V Sprague "Orange Drop" capacitor
- 1 tube clear silicone caulk (similar to bathtub caulk)
- 1 can PlastiDip (something like liquid rubber)
- 2 rolls of cloth medical tape 1.5 inches (4 cm) wide
- 2" (5.1 cm) of soft clear plastic tube, 5/16" (0.8cm) internal dia.
- 20" (51 cm) of soft clear plastic tubing 1/16" (0.16 cm) internal dia.
- 225 turns (1000 ft. or 228 m) of 18 AWG (0.102 cm dia.) magnet wire as secondary windings.
- 3 turns of 18 AWG (0.102 cm dia) magnet wire as primary.

Construction Details.

No steel parts are used, to avoid corrupting the magnetic field. Brass and plastic are used throughout.

The bubble level is mounted on one of the Plexiglas disks which are then used to seal the hub of the wheel. Silicone caulk is used to ensure a watertight seal under the disks and in each screw hole.

The cutout is mounted between the spokes and the junction box is attached using the brass bolts, which will also serve double duty as the primary-winding terminals. The junction box is connected to the valve-stem hole using the larger plastic tube and lots of silicone caulk. The four wires which run through this tube are insulated from each other by pieces of the smaller plastic tube.

The three-turn primary winding is made first. Then, before the secondary windings are added, both small plastic tubes for the secondary are put in place so the outer end can be fed down to the junction box. The secondary winding is wound in layers with care to prevent scratching the thin insulation and to avoid high voltage potentials

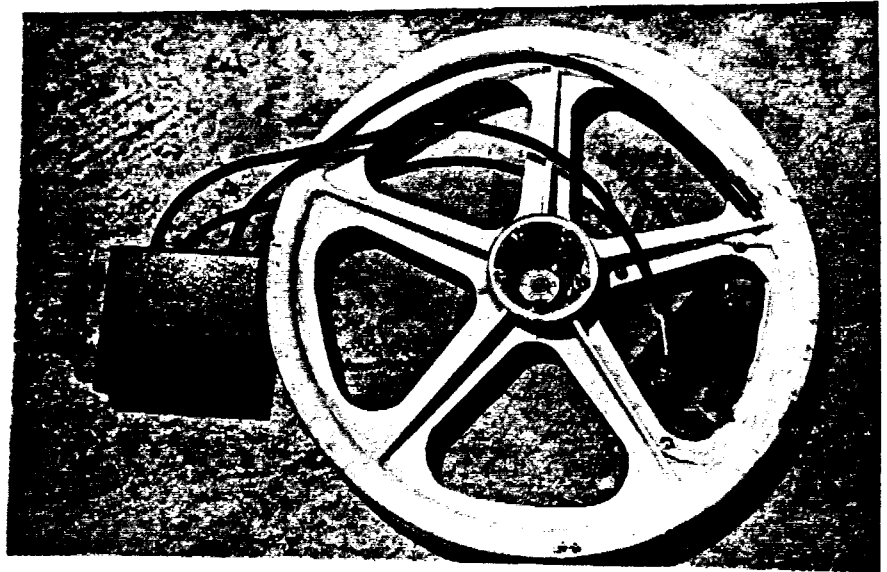

between adjacent wires. The layers are wound to minimize air-gaps. After all winding is done, the wire nearly fills the channel of the wheel rim but does not protrude. This is desirable to protect the soft wire from damage (the wheel takes all the blows).

The coil is first covered with medical tape wrapped a few times around the circumference of the coil in the same direction as the wire was wound. This first wrap should overlap the edges of the rim a little. The second wrap is applied in a spiral around the thickness of the rim with lots of overlap on each turn. The spokes are somewhat annoying during this wrap. Cloth tape is used to provide a rough surface for the PlastiDip to adhere to. PlastiDip is available in liquid and spray form. I pour the liquid into a trough and dip the edge of the wheel in it. After rotating the wheel slowly to cover the entire taped area, a brush can be used to touch-up holes and thin areas. Two coats of PlastiDip seems to be enough.

The capacitor connected to the secondary windings was selected for best transmitted power. I used a turn of wire connected to an oscilloscope as a receiver to measure relative transmitted power when selecting the capacitor. Once the capacitor is finally installed, taking good care to keep the two ends of the primary well isolated, the junction box is half-filled with silicone caulk to insulate all vital connections.

The antenna is used for transmitting only, at a frequency of 3.580 kHz. The 12 volt battery delivers 1.9 Amps during operation, but actual power to the antenna is not known, nor is the "Q" of the antenna. The coil is rugged and small enough for transport in most caves. It has four very convenient hand-holds and can be levelled in seconds.

This antenna should work underwater with modifications to the wingnut connections. No high voltages are exposed and everything is watertight. To be safe though, I would rather use fewer windings of larger wire in an underwater unit to reduce the voltages produced.

THE MENDIP RESCUE ORGANIZATION (MRO) ANTENNA

by Brian Prewer.

The MRO cave radio is based on the South Wales Caving Club design by Bob Williams and Ian Todd. The design was published in "Caves & Caving" No 35, Spring 1987, p 1-7, (this article was reviewed in Speleoneics 7, p16).

The details of the antenna are as follows:

Size 1 m x 1 m square.

Coil is fabricated from 64-conductor ribbon cable.

(Ed note, probably 28 AWG or 0.32 mm dia conductors)

The supporting frame is made of 3/4" (1.9 cm) dia. ABS compressed-air pipe. The central boss is made of nylon. (see sketch).

The whole assembly packs away into a small tackle bag which houses the support arms, coil, central boss, and connecting cable to the transmitter.

The antenna is used for both transmitting and receiving voice communications, and is tuned at 87.5 kHz by a specific length of miniature coaxial cable about 1 m long. Power input is 10 watts.

The main disadvantage of this antenna is the number of turns required thus making the whole assembly rather clumsy. The ribbon width is 4" (10.2 cm) and requires a fairly stout support frame. The joining of the ribbon cable is done (very tediously) by direct soldering and sleeving and finally moulding in a clear epoxy resin, with the tuning coax. cable being wrapped around the resin block. Two small sockets are set into the resin for connection to the primary winding. The whole thing should be waterproof. Soldering and moulding the whole connection area in a block of resin appears to be the best method in view of the high RF voltages present and the amount of mud and moisture likely to be encountered. So far, there have been no problems with this system.

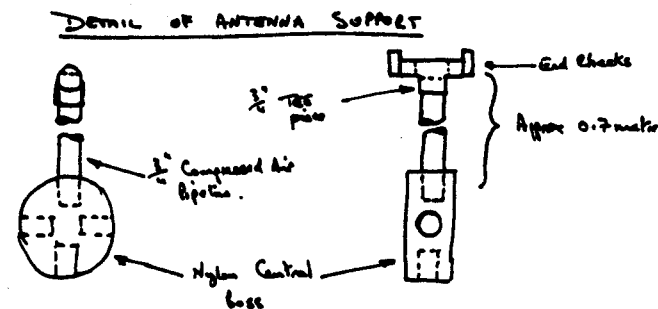
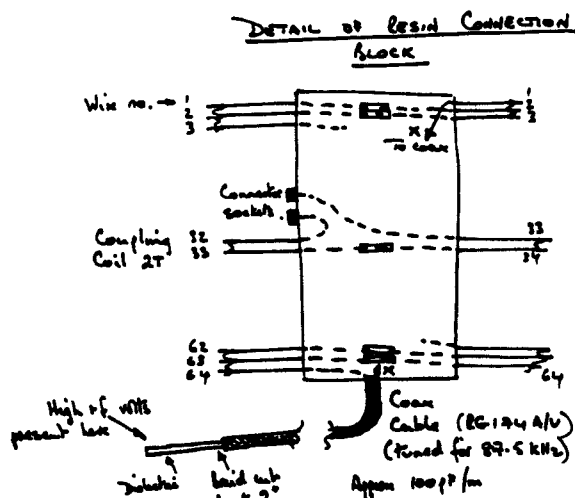

THE ASS "GIANT" ANTENNA

by Ian Drummond

The Giant antenna was built to provide voice communication at extreme range (300 m + depth) with the ASS cave radio. (see Speleoneics 5 for circuit description of the radio). Once deployed, it cannot be moved or rotated and so cannot be used for location work, except as the transmitter antenna.

Size 13 x 13 m square; Operating frequency 115.4 kHz. The antenna is used for both transmitting and receiving.

Components :

- 52 m of 18 AWG (0.102 cm) 2-conductor, multi-strand, plastic-insulated wire.
- Metal junction box.
- Polarized 2-pin locking plug and socket.
- Small neon bulb and 150 k resistor.
- Selection of 630 v silver-mica capacitors about 1-4.7 nF.
- Amidon "E-core" or 18 mm pot-core.

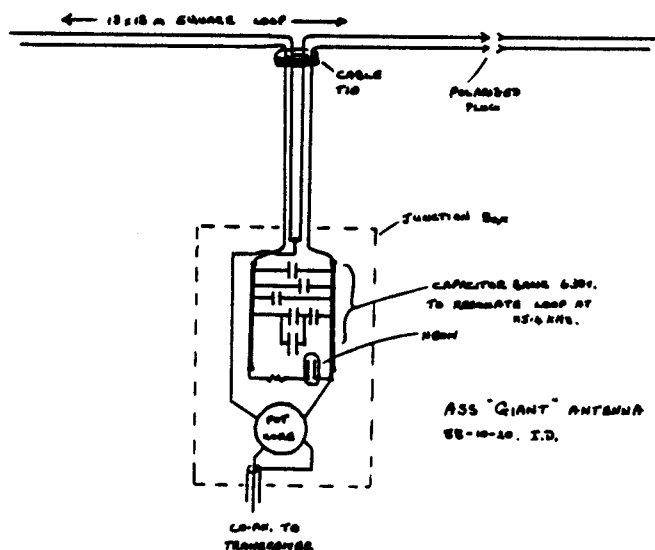

coax cable and fittings.
perforated mounting board.
nylon cable ties.
conformal silicone coating.
3" (7.5 cm) of solid 18 AWG (0.102 cm) copper wire.

Construction.

The two ends of the 2-conductor wire are bound together with the nylon ties about 4" (10 cm) from the ends as strain relief. The four conductors are bought into the junction box. The wire is connected to form a two-turn loop with a centre tap, and the ends of the coil are connected to two solid-copper wires mounted on the perforated board. The capacitors, each about 1 nF, necessary to give a current rating of over 1 Amp, are connected across the two copper wires. A total of about 4.5 nF is needed to resonate the 52 m square loop at 115.4 kHz.

The neon bulb is stuck with epoxy resin inside a small hole drilled in the junction box, and then connected in series with the 150k resistor across the two copper terminals.

The 50-Ohm output of the transmitter is matched to the antenna by a broad-band transformer formed from an "E-core" or pot-core. Wind the primary (transmitter) turns first, 6 turns for an inductance of approx. 0.1 mH; then the secondary turns, about 40, which is slightly more than needed. The secondary windings are connected to one copper terminal wire and the centre tap, the primary windings are connected to the coax cable and fittings.

The unit is now ready for final adjustment. The

52 metre loop is laid out in a reasonably accurate square away from metal conductors, lawn furniture, etc. It helps to mark the corners of the square on the wire for future use. Use a signal generator to apply a signal of known frequency to the coax cable. Vary the frequency to find the resonant frequency (i.e., frequency of maximum input impedance). Add padding capacitors in the junction box until this frequency is within 500 Hz of the tone transmit frequency (115.4 kHz). Now connect the transmitter and measure the voltage and current being supplied to the antenna when transmitting a pure tone (CW signal). From this, calculate the resistance of the antenna (The antenna at resonance presents a pure resistance to the transmitter, so volts/amps = Ohms). Adjust the turns on the transformer secondary to match the transmitter output impedance (50 Ohms).

Two final steps remain. I sprayed all the components in the junction box with a silicone conformal coating to provide some protection. Also, I found the coil to be very difficult to handle around trees and bushes, so I cut the loop near the junction box and rejoined it with a polarized plug and socket which locks together. That way the loop can be deployed by walking around the perimeter of the site, paying the wire out behind you.

Electrical parameters

Secondary voltage	210 v RMS
Secondary current	1.0 A
Q	29
Input power	9 w
Magnetic moment	340 A.m ²

RECEIVING CAVE-RADIO SIGNALS WITH A WHIP ANTENNA

by Ian Drummond

Cave radios work by generating a magnetic field which is detected by using a loop antenna at the receiver. How, then, could a signal from a cave radio be received using a whip antenna which works by detecting the electric field of an electromagnetic wave? In truth it is impossible for a time-varying magnetic field to exist without a corresponding time-varying electric field existing too.

This is readily demonstrated in practice. I have a Burhans Electronics whip pre-amplifier with a 36" (92 cm) whip antenna permanently mounted in the loft of my house (see "Resources" section). It is connected to a Heathkit SW 7800 general coverage receiver, and I was able to receive the ASS radio transmitting on 115.4 kHz from 100 m distance. This is perhaps 0.5 to 0.7 of the distance I would have obtained with the small loop antenna under the same noisy urban conditions. I did not have time to experiment with antenna orientation

for best reception, but the experiment clearly shows that whip antennas are practical options for cave radio receivers, even when the transmitting antenna is a loop.

Incidentally, the Heathkit receiver can be powered by a 12 v battery for portable operation. Although the manufacturer claims coverage only down to 150 kHz, my unit performs well down to 10 kHz. I have no trouble receiving the OMEGA navigation signals in Calgary from Lamoure, N. Dakota, USA on 10.2 - 13.1 kHz.

For people who have receivers which do not tune to such low frequencies, Burhans also offers an up-converter, so that the range 10 - 400 kHz is converted to 4.010 - 4.400 MHz. With the Heathkit receiver I can detect no difference in performance between the direct signal and the up-converted signal.

Magnetic Moments #8: ANTENNA NOISE

by Ian Drummond.

The last "Magnetic Moments" had a discussion of the natural sources of noise in the atmosphere, and showed how the noise field strength in microamps/metre could be estimated for a given place and time on the Earth's surface.

A second source of noise which obscures the desired signal is the receiving antenna itself. Any physically real antenna has electrical resistance and there is thermal noise associated with that resistance.

A.D. Watt deals with this problem in "VLF Radio engineering", Pergamon Press, 1970. and derives the following relationship for air-cored loops, transformer coupled to the receiver.

$$H(\text{noise}) = -27.9 -10\log f -15\log A +10\log K -10\log Q +10\log B + N_t + F_v$$

(dB rel. 1 microamp/m)

where

- f = frequency (Hz)
- A = area of loop (m²)
- K = induction factor (fig. 1)
- Q = antenna Q factor
- B = receiver bandwidth (Hz)
- N_t = transformer degradation factor (dB)
- F_v = Receiver noise factor (dB)

The noise field of the antenna can be compared to the atmospheric noise field to determine which is predominant. For small loops sometimes antenna noise can in fact exceed the atmospheric noise. Thus a larger (and thermally quieter) antenna could improve system performance. Once the optimum size is reached, however, no increase in the receiver system performance will result simply from a larger antenna; that is, the signal-to-noise ratio at the receiver input will not be increased by a larger antenna.

For example the noise field of the small ASS cave radio antenna can be compared to the atmospheric noise found in Alberta.

$$\text{Inductance} = K \cdot A^{0.5} \cdot N^2$$

microhenries

Constant		-27.9
f = 115400 Hz	-10log f =	-50.6
A = 0.5 m ²	-15log A =	+ 4.5
K = 2.8	+10log K =	+ 4.5
Q = 80	-10log Q =	-19.0
B = 1500 Hz	+10log B =	+31.8
N _t = 4 dB (assumption)		+ 4.0
F _v = 3 dB (assumption)		+ 3.0

		-49.7 dB
		(rel 1 microamp/metre)

In Magnetic Moments #7 the noise field strength at 115.4 kHz in a bandwidth of 1500 Hz, on a summer afternoon in Alberta, was derived as -39 dB (1 microA/m). Thus under these conditions the antenna noise field is 10 dB below the atmospheric noise and (quite by accident) the receiving antenna would seem to be about the optimum size! In fact Alberta can be significantly quieter at other times and a larger receiving antenna can be beneficial in extending range under these circumstances of lower atmospheric noise.

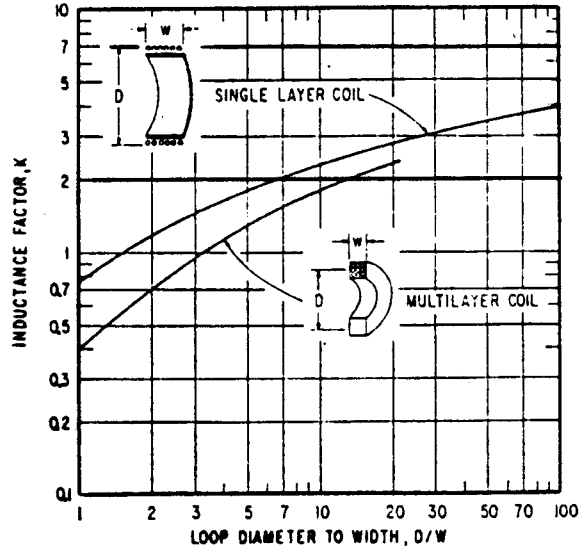

Inductance factor k as a function of loop diameter to width ratio.

COIL-WINDING MACHINES

Frank Reid

Winding, tuning and packaging antennas can be the most difficult part of cave-radio construction. Here are two designs for winding-machines for the rigid, multiturn, resonant coils used with my 3500-Hz cave radio, and a few notes on coil design.

Ring-of-Nails Coil Winder (used by Dick Blenz in his pioneering experiments). Bolt or glue a standard V-pulley to the center of a sheet of plywood larger than the diameter of the finished coil. The board may be square or circular; a cable-spool end works well. Scribe a circle on the board, concentric with the pulley. This circle will be

the inside diameter of the coil.

Drill small holes through the wood, about 4 cm apart, around the circle's perimeter. Push nails into all the holes, leaving about half the nails' length protruding. Mount the assembly on the shaft of an electric motor - attached to the edge of a table. (The motor is not powered; it is only used as a spindle.) Secure the end of the wire to one of the nails, then rotate the board, winding wire around the outside of the circle of nails. When winding is complete, tie the bundle together with string in the old-fashioned cable-lacing method before removing the nails. (Waxed dental-floss makes good cable-lacing string.) Remove a

few nails to free the coil from the board, then wrap the coil with electrical tape. If you are making a coil of several separate bundles of wire (see below), make concentric nailhole-rings of slightly different diameters (or remove a few nails) so that the finished bundles will nest.

It's easy to lose count of turns while winding. A turns-counter can be made from a mechanical counting mechanism mounted on the face of the winding machine, with an eccentric weight attached to its shaft or lever arm such that the counter advances once per revolution.

Bicycle-Rim Coil Winder: Attach a pulley to the center of a board, as above. Cut a bicycle wheel rim (without spokes) with a hacksaw, and spread the cut ends apart several centimeters. Use wood-screws and flat washers to secure the rim to the face of the board. Wind wire around the rim, then loosen the screws near the cut ends of the rim and squeeze the ends together to loosen the coil enough that it can slide around the rim while you lace it together at the gap. After lacing, squeeze the ends of the rim closer together to free the finished bundle from the winder. You can make nesting coils of slightly different diameters by varying the gap length.

Coils built in standard bicycle-tire diameters can be housed inside bike inner-tubes for protection. Split the tube all around its inside diameter, stuff the coil inside, remove the valve core and bring the wires out through the stem, then glue the tube back together with Shoe Goo[™] or wet-suit cement. Clean the rubber with solvent before gluing. Hold the assembly together with tape while the glue dries. Coils which are not standard bike-tire diameters can still be covered by inner tubes-- remove or add a section of tube as required. Wires could be brought out through the glue joint instead of the valve stem; the valve could then be used to introduce dry air or gas to expel moisture. Use plastic cable-ties to secure the finished coil to a board or framework.

Bicycle tires make especially durable coil covers. **NOTE:** Bike tires have steel wires inside the beads, which must be cut to prevent their acting as shorted transformer windings.

Coil Design: There are several advantages to "pie-wound" coils, i.e., coils made from several separately-insulated bundles of 100-150 turns each, rather than a single large bundle: (1) High-voltage breakdown problems are decreased because the voltage between adjacent wires is limited, (2) the self-capacitance of the coil is decreased, allowing more turns before reaching self-resonance, and (3) the Q of the coil is increased.

Receive-only coils do not have high-voltage problems, but should be pie-wound for reasons (2) and (3) above. The only critical part of "pie" construction is proper phasing of the bundles: They must all be connected such that their magnetic fields add. After building all the bundles, label the top and bottom of each bundle. Place each bundle in a vertical North-South plane, with a magnetic compass in the center. Connect a flashlight cell to the wires, observe the direction of the compass-needle swing. Label the wires "+" and "-" such that the compass needle points to the "top" side of each bundle. Assemble the coil with all bundles' tops up, and wired in series (+ to - to + to -, etc.).

The "Q" factor of a coil is its inductive

reactance divided by its resistance. Inductance is proportional to the square of the number of turns, and resistance is proportional only to the length of the wire, therefore, a coil with many turns will have higher Q than one with few turns.

Self-resonance limits the number of turns a coil may have. Since there is capacitance between the wires of a coil, it becomes a parallel-resonant circuit at some frequency. Above the self-resonant frequency, the coil's reactance is capacitive rather than inductive. Since inductance increases much faster than resistance, and inductive reactance increases with frequency, the maximum Q occurs at self-resonance. Higher Q means higher coil current but there will be correspondingly higher voltage across the coil and capacitor, with accompanying problems of insulation breakdown. Resonant cave-radio transmitting coils commonly develop more than 1000 volts. The self-capacitance of a coil is somewhat unstable; practical coils should have a self-resonant frequency somewhat higher than the operating frequency, and be CAREFULLY resonated with SELECTED capacitors. When building cave-radio transmitter coils for audio frequencies, I've always run out of wire or reached a size/weight limitation before self-resonance became a problem. Blenz once encountered the self-resonance limitation in a 4-foot (1.2 m)-diameter receiving coil intended for 7-kHz operation.

Calculating the Q from a coil's dc resistance will be misleading; coils appear to have higher resistance at the operating frequency because of skin effect, which causes ac current to flow on the outside of conductors, and proximity effect wherein a strong magnetic field forces the conduction electrons toward one side of the wire.

RESOURCES

[Unsolicited listings of sources of useful equipment and information.]

DIGITEMP[™] BATTERY TESTER
Hallcrest Products
1820 Pickwick Lane
Glenview, Illinois 60025 USA

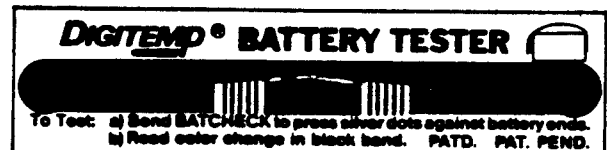

(2/3 actual size)

Russian cavers were properly astounded when Peter Ludwig showed them this ingenious device.

It's a no-moving-parts voltmeter for testing 1.5-volt cells. A 1" x 5" (2.5 x 12.7 cm) strip of flexible plastic is printed with conductive ink, covered with liquid-crystal material which changes color when heated. The tapered conductor is narrower at the middle. The liquid crystal changes color in a band whose length is proportional to voltage. Bare conductive spots at the ends contact the poles of the cell under test.

The Digitemp's 3-ohm resistance provides a reliable cell-test under load. (High-impedance voltmeter tests can be misleading; depleted cells

may have near-full voltage at no load. Carbon-zinc cells are often tested with an ammeter instead of a voltmeter; this practice is not recommended for alkaline cells.)

Hallcrest offers other liquid-crystal thermometer products, and a paper humidity-indicator card having a series of cobalt chloride strips which change color (blue to pink) at different relative humidities.

BURHANS ELECTRONICS
161 Grosvenor St.
Athens, Ohio 45701 USA

Ralph Burhans is a retired Professor of electrical engineering who is designing receiving equipment for the 10 - 400 kHz range. He also writes clear articles explaining exactly how his equipment functions; and this stuff certainly does work! Current offerings are a whip-antenna-matching preamplifier, a loop-antenna-matching preamp., and a DC coupler to power either preamp. An up-converter for changing 10 - 400 kHz to 4.010 - 4.400 MHz, based on a switching mixer design, is also available. Units are available as assembled, tuned and tested boards for reasonable prices. Write for catalog.

BAT CONSERVATION INTERNATIONAL, INC.
P.O. Box 162603
Austin, Texas 78716-2603 USA

The illustration below is from BCI's fall-winter 1988 catalog, which was sent to all NSS members. We hope that someone will write a product review of this device for SPELEONICS. It might work as a VLF receiver if the microphone is replaced with an antenna or, better still, a Burhans preamplifier.

BCI is a very worthy cause. Their catalog features bat houses, literature, jewelry, T-shirts, greeting cards and many other bat-items.

Listen in with a QMC Mini Bat Detector!

With your QMC Mini Bat Detector, you'll be able to hear the echolocation signals of bats as they navigate the night skies, catching insects. Many have detectably unique ultrasound patterns, their presence, and sometimes even their specific activity, can be detected by sound alone! The bat detector is a valuable and exciting educational tool for park or nature center interpretive programs, as well as for individuals who want to learn more about bats.

Pocket-sized; operates on AA batteries; sensitive microphone covers all known animal ultrasound, frequency range from 10kHz to 160 kHz; output socket for earplugs (supplied) or tape-recorder; clip-on horn for direction finding. Imported from England.

E-1 QMC Mini Bat Detector \$210.00
Member \$190.00

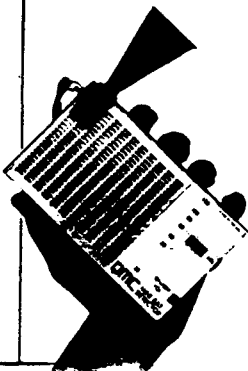

MOUSER ELECTRONICS
P.O. Box 699
Mansfield, Texas 76063
(800) 346-6873 (includes Canada)

Mouser is an electronic parts-house in the old tradition, and an invaluable source of small quantities of the latest semiconductors and other components for the individual experimenter. The Mouser catalog includes a line of RF and AF transformers which are especially useful in VLF

projects. There are regional branches in California and New Jersey.

PORTASOL (tm) "PROFESSIONAL"
Soldering iron / blowtorch / heat gun
Distributor: GC-Thorsen
1801 Morgan St.
Rockford, Illinois 61102 USA

Cavers have praised the Irish-made Portasols, which use cigarette-lighter fuel. They are valuable expedition and emergency tools for field electronic and mechanical repairs. Its various-sized soldering tips contain catalytic gas burners. A valve controls output up to 60 watts. The new "Professional" model adds an open-flame feature, with two torch tips. "Professional"-series tips are NOT interchangeable with older Portasol products. The "Professional" kit (catalog #12-180) costs approximately \$60, available from electronics suppliers. The older (orange-colored) model has been seen for as little as \$25 at hamfests.

Underground radio

Mick Hamer's statement, in "The night that luck ran out" (7 July, p 31), that "it is impossible to communicate underground by radio unless the two radios are in direct line of sight of each other" is incorrect. For many years, the mining industry, both in Britain and overseas, has made extensive use of radio communications techniques in both its day-to-day mining activities and during emergencies.

Effectively, there are three ways of using radio underground. The first is to operate at a low enough frequency so that the electromagnetic energy actually penetrates into, and propagates through, rock, coal or even reinforced concrete. This approach has achieved particular success in the South African gold mines over many years and has led to the development of special-purpose equipment for this application. Incidentally, a similar technique was reported to have been used successfully for emergency service communications after the Moorgate tube disaster some years ago.

The other two approaches both rely on the existence of cables to assist in the propagation of the energy along passages and tunnels. If the low-frequency radio equipment is in fairly close proximity to any cabling, be it power, lighting or telephone lines, then radio signals will be induced into them and will propagate and re-radiate. Communication is thus possible between suitably equipped personnel along routes served by common cable systems.

The third method requires the prior installation of so-called "leaky feeders" or radiating transmission lines—usually coaxial cables, which allow high-frequency (typically VHF) signals to leak in and out of the cable from radio transceivers within some metres of the cable. Such systems are used extensively, both within mines and in high-rise buildings.

A final comment on the statement that emergency service



vehicles "had to park more than 15 metres apart so as not to interfere with each other's radio traffic". This situation is all too common and has concerned the military for years. It underlines, yet again, the importance of electromagnetic compatibility ("Electronic smog fouls the ether", *New Scientist*, 7 April, p 34) as a key element in modern electronic systems design. Brian Austin
Department of Electrical Engineering and Electronics
University of Liverpool

(Letter to
New Scientist
July 1988
p. 101.)

MONITORING MAGNETIC DECLINATION (combined reprints)

In an article on the cavers' computer-mail distribution list, **Bill Putnam** (putnam@gatech.edu) writes:

... Has anyone had experience with correcting for magnetic declination changes over time in long cave surveying projects? ... Annual rate of change of declination... is currently about 20 minutes/year in this area... It is common practice in the southeast to ignore declination, since it is less than 2 degrees everywhere in the region and is zero in the areas of highest cave density. In my case, magnetic north has moved by over 3 degrees... in the last 20 years. This makes it necessary to apply some corrections...

It would be helpful if I could find a set of maps dating back to the 60's... USGS topos are updated rather infrequently - maybe FAA charts would be better.

Frank Reid (reid@gold.bacs.indiana.edu) replies:

Change of magnetic declination (which navigators call variation) becomes significant in cave mapping projects lasting longer than five years. Although declination is small in Southeast and Midwest USA, the rate of change there is high. The agonic line (line of zero magnetic declination) is moving westward. It was at Lexington, Kentucky in 1950, and is now near the western tip of the state. It passed through Ellison's Cave in 1975 and Mammoth Cave in 1976, i.e., the declination changed from east to west. (There is another agonic line in the Eastern hemisphere.)

The U.S. Geological Survey publishes magnetic declination charts every five years, which are maps of continental U.S. with isogonic lines. Current and old maps can be found in university geology libraries. The declination is surveyed on a one-degree latitude-longitude grid; local variations may differ due to regional magnetic anomalies. Aeronautical charts duplicate the USGS data. The 1985 data did not appear on sectional charts until 1987.

In addition to the slow drift of magnetic declination, there are short-term changes: Diurnal (daily) variation is insignificant in central U.S. but may be 5 degrees in the Pacific northwest. Magnetic "storms," perturbations of the Earth's magnetic field caused by solar flares, sunspots, etc., can deflect a compass several degrees in a few hours, and can last for a few days. During times of maximum sunspot activity (an eleven-year cycle which will peak in the next two years), there are major magnetic storms and the aurora borealis is occasionally visible as far south as Georgia. See Sky & Telescope magazine, Oct. and Nov. 1988.

Cave Research Foundation surveying procedures require recording calibration data for each compass immediately before a cave trip, using a set of benchmarks whose true azimuths have been determined by Polaris sighting with a surveyor's transit.

--

U.S. Geological Survey benchmarks are usually accompanied by one or more additional bronze discs at precisely known azimuths from the main benchmark. Fixed azimuth references can be used for determining local magnetic declination. Establishing your own azimuth-reference monuments in convenient places may be preferable to searching for

government benchmarks and their associated data.

Surveying texts describe several methods for determining true North by astronomical observation. Most require complex computations and expensive equipment (transit or theodolite, short-wave receiver for time signals, electronic calculator). There are also simple procedures:

ESTABLISHING A TRUE NORTH MERIDIAN

from "Surveying, Theory and Practice", by R.E. Davis and F.S. Foote, McGraw-Hill 1940

The true meridian is established by astronomical observation...

On compass surveys, in order to determine the magnetic declination, sometimes true north is established by ranging two plumb lines with Polaris, usually when the star is at elongation (farthest east or farthest west). If the time is accurately known, the observations are sometimes made when the star is at culmination (directly above or below the pole and hence on the meridian). One plumb line is suspended from some convenient high point, and a stake with tack representing the north point of the meridian is set beneath the bob. At a distance of 15 or 20 ft. south of the plumb line two stakes are set, one on each side of the estimated position of the meridian, and a piece of stout string is stretched between nails driven in their tops. A second plumb line is suspended from the stretched string. When the time of elongation or culmination approaches, the observer moves the second plumb line, keeping the two plumb lines in line with the star until the time of elongation or culmination has been reached. A stake with a tack is set beneath the second plumb line. If the star was at culmination the tacked stakes define the true meridian; if the star was at elongation the true meridian is established by laying off an angle from the established line... If the observation was made at western elongation the angle is turned clockwise; if made at eastern elongation the angle is turned counterclockwise. ... (Ed. note, In 1945 the azimuth of Polaris at elongation, latitude 50°, was 1° 33.1' and had decreased 4.0' in 9 years, so presumably in 1988 it is close to 1° 14'.) The first plumb line will usually need to be illuminated with artificial light. To dampen the swing, the bob may be immersed in water. For some minutes preceding and succeeding the instant of elongation the star appears to move vertically, hence observations ... are not influenced by time errors and need not be hurried. If ... care is exercised in setting the ground points, the error in determining the meridian in this manner need not exceed 05'.

--

It might be useful and interesting for cavers to establish magnetic observatories. Caves, having constant temperature and isolation from other mechanical disturbances, should be desirable sites. Plans for a simple compass magnetometer appeared in a letter to the editor of The Lowdown (July 1988) by British VLF experimenter Mike Scrivener. (A strong bar-magnet is suspended in oil; a Hall-effect sensor near one pole is connected to an amplifier and chart-recorder or digital data-logger. The same device was published in the first BCRA electronics newsletter; see review on page 1.)

ELECTRIC DRILLING-HAMMERS FOR CAVING

Peter Ludwig *

1. Ethics

Some cavers believe that drilling holes in cave walls is bad. This article is only technical information. Many European grottos (especially German and Austrian) use this "hi-tech" method with excellent results, for safety and other reasons. It made many explorations possible. All of them use it for cave rescue.

2. General

Drilling-hammer technology was invented by the firm HILTI in Liechtenstein, a country between Austria and Switzerland. The main difference between a drilling hammer and a standard impact drill like everyone has at home is that the energy from the motor goes mainly into the impact and not into rotation. It is therefore much more efficient for drilling in rock and concrete. On the other hand, this principle is much more expensive to make and was covered until a few years by HILTI's patents. They are now offered by many manufacturers.

In a standard impact drill, only two serrated disks are pressed together to produce the impact, so you must press very hard to get acceptable results. A drilling hammer needs only minimal force to press the drill against the rock; a pneumatic piston works like an air compressor and forces a secondary piston to impact the drill. The air between them is only a medium to store energy for a short time. The impacts are much harder and so most of the drilling hammers use special inserts instead of standard rock drills. These inserts have a standard-sized shaft of approx. 10mm dia., and 4 slots (two of them are round, the other two have edges), and are called SDS-Plus (except original HILTI, which have only the two round slots). It is possible to use SDS-Plus inserts in HILTI machines but not vice-versa. On most hammers you can disable the impact and use them for normal drilling (with a special adapter and a standard head). On some very few types you can also disable the rotation and use the whole thing as a power chisel.

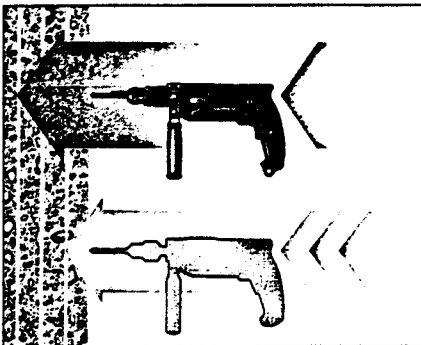

Pneumatic-coupled electric drilling-hammer drills faster with less hand force than conventional impact-drill.

3. Battery-powered hammer drills

There are now three brands available.

3.1. Bosch GBH 24 V

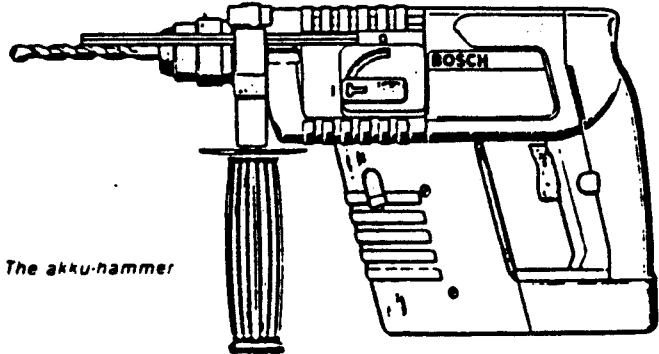

The akku-hammer

The Bosch was the first battery-powered hammer drill on the market. It has a 24V 1.2 Ah NiCd power pack and works very well. Its power consumption is 265 W and it weighs 3.6 kg with power pack. In very cold Austrian cave conditions, one charge can usually drill some twelve 8mm anchor-holes in the rock. The charger charges 2 hours at 0.8 Amps, independent of the charging state. Deep discharge has caused many power-pack failures in commercial use. The whole set is sold in Western Germany for about \$350. There are sometimes special offers of the same price with two power packs and some drills.

3.2. HILTI TE7A

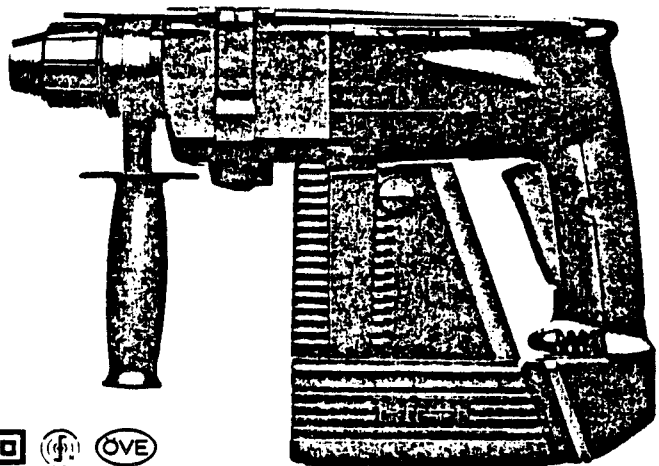

* Gfollnerstrasse 6
A-4020 Linz
AUSTRIA EUROPE

[The U.S. Post Office may send your letter to Australia if you omit EUROPE. --ed.]

The HILTI appeared later than the Bosch on the caving market, but I think HILTI started the development first and did more research. I asked at HILTI's many years ago why there is no battery-powered drilling hammer. They told me that the available power packs were not good enough for this extreme high-power application. The HILTI uses a 36V, 1.2 Ah power pack (30 sub-C cells) and has a built-in power cutoff against deep discharge. The power pack is also electronically protected against high-temperature charging and overheating (this is not a problem in our caves; temperature is typically 20°C). There is a small SMD plate in the power pack. The HILTI's weight is 4.2 kg w/ power pack. The HILTI seems to be much more efficient than the others; you can usually drill about twice the holes as with the Bosch (but the power pack is only 50% larger). Its power consumption is about 360 W. Its charger seems to be slightly more intelligent than the Bosch; I think it controls charging by measuring the temperature. The power pack has two additional terminals, one for charging and one for switching on while doing the job.

3.3. The BBC ??

This drilling hammer is comparable to the Bosch, but works at 12V. I have no further information about it, and it seems to have no advantage.

4. Using them in a cave

4.1. Setting bolts

The best description of this is West German caver Daniel Gebauer's article in *Caves & Caving* 34 p 30. We use 8mm bolts with great success; they must be used intelligently. If you consider your life worth larger bolts, use them; choice of bolts also depends upon the rock. The rock in our alpine caves is very hard and solid, so an 8mm anchor is good for some 14 kN (3000 lb) on shear load and 17 kN (3800 lb) on rectangular load. We usually place more than one bolt at rebelay. We now use self-locking nuts instead of standard nuts. I think it is better to use more small bolts at the same anchor instead of using larger bolts. It also seems that efficiency is higher with smaller drills. If you have weaker rock, then longer and thicker bolts may be required; but then less energy is needed to drill soft rock.

4.2. Artificial steps

Since we have the drilling hammers, we use artificial steps and grips more often in cave passages which we must traverse many times. For this purpose we use 100mm (4")-long 10mm (7/16") bolts. The first 25mm (1") are covered with several layers of duct tape. A 10mm (7/16") hole is drilled and the now-oversized bolt is driven in with a hammer. This system works very well but you need another drill size. We now try to use special (homemade) hangers which we can use as steps too (with an anchor).

4.3. Chisel work

We have a pointed-chisel insert which we have never needed in a cave, but we made some tests. It should be advantageous in very tight areas where it is not possible to use a hammer. There is now a

new blade-chisel available, which disables the rotation.

4.4. Drilling blasting-holes

Although the user's manual says that you can use them only up to 16mm (5/8"), we tried the HILTI and the Bosch with a 20mm (7/8") drill. They did well, but need a lot of energy because it is hard for the machine to accelerate the large and heavy drill. This is only usable if large quantities of electricity are available (see below).

4.5. Funny things

I want to make a small propeller for our grotto's caving raft and drive around underground lakes if we have leftover energy in the power packs.

5. General hints

5.1. Drilling points

Our experience is that more-expensive high-quality drills are worth their cost. They weigh the same as cheap ones, but can drill more holes with the same power-pack.

5.2. Backup

Try not to depend on your machine; as with all technical things, it may have trouble. Take along a star-drill for the same hole-diameter (you usually have a small hammer with you for testing the rock before drilling).

5.3. Terminal maintenance

At high current and relatively low voltage it is especially important that connectors be in good condition and covered with contact grease.

6. Improvements

6.1. Additional power packs

I made several power packs of different sizes for our Bosch and HILTI machines. Don't try to make a power pack with the original terminals; it's not worth the work-- For this reason, I attached a cable to the machine and made belt-mounted power packs. There are several advantages:

You have less weight in your hand (great!) and can work better while hanging on the rope.

You can use larger power packs, shaped as desired.

You can put them under your suit and get more holes per power pack because it's warmer there.

You need an attachment from the machine to your harness, so the cable is no drawback.

I made power packs with 24V / 4.5Ah (for long technical trips) and 24V / 1.5Ah for the Bosch. I use 2.5mm high-flexibility loudspeaker cable inside 3/4" tubular webbing, which is also the machine's attachment to the harness. I use AMP connectors which are usually used for RC-cars. These connectors are now nearly standardized among Austrian and West German cavers.

If you make your own power packs, you can use inexpensive special offers and higher capacity (at the same size) nicads. Because these are not as well-matched as the cells from original power packs, it is much more important to avoid deep discharging. The best solution for cavers will be to contact other grottos which use drilling-hammers, buy a larger quantity of cells, and select them for different power packs).

6.2. Charging improvements

Usually the original chargers are the quick type (some with ridiculous methods like time-counting or thermal shutoff). Fast charge is usually not necessary for caving. Try to change the charging current to a lower value (or better, install a switch for both possibilities), and you will have a longer battery life and maybe a fuller power pack. This is especially important when charging from an unknown charge state. A DC/DC converter for charging them from a car battery would be very nice. For expedition use I would like solar cells for charging. In our underground camps we use large kerosene lanterns which produce beside 1kW of heat in addition to light, so I'm working on a thermogenerator for charging the power packs underground.

6.3. Circuits in the machine

6.3.1. Anti-deep-discharge cutoff

Deep discharge is very bad for your power pack's life-cycle, especially if you use home-made power packs. If you have a machine with no built-in cutoff, try to make one from a standard (multiple) operational amplifier. If you think it too complex to cut off the high current, use a deep-discharge alarm (beeper), and hope that the caver using the machine is smart enough to stop at the moment. A flashing LED is also useful for pre-warning (so you can see that there is not enough energy left for a new hole). I made the thresholds for the cutoff (or the beeper) at 0.95 V per cell, and the warning at 1 V (under load!).

6.3.2. Power control

If you make a built-in power control, it will also be possible to use small power packs which are not able to give very high power (or something like the Mollicell batteries). Power packs usually have better efficiency at lower loads, so you may desire to drill more slowly (which is still much faster than manual drilling).

6.4. Miscellaneous

For using the machine in very tight spaces, you can make an additional cord for using the machine alone, with the power pack behind.

For rescue purposes you can make a special cable to connect the machine to two (Bosch) or 3 (HILTI) small car or motorcycle batteries, if you need a lot of holes (blasting) and have enough people for support. I also made a hand-held 24V 60W halogen light for the same connector, so I can use the Bosch power pack for it. This device is relatively lightweight (less than one pound) and helps a lot for discussing (artificial) climbing routes and for demystifying the huge passage starting high in a dome. It is best to install a momentary switch and to use it only for short

periods. A better (high-tech) solution will be an overrated 12 V bulb and a switching regulator. For cold caves I thought of using a small liquid-fueled handwarmer to warm the power pack, especially large packs (3% more weight yields 10% more capacity).

6.5. Making your own hammer-drill

It is also possible to take (buy, steal, find) an old or broken 120V or 220V drilling hammer and replace the AC motor with a low-voltage DC motor. There are excellent motors available for RC-racing cars, with ball bearings and high-tech design. They are extremely lightweight for their power output, and highly efficient. The lightest drilling hammer now offered is a Bosch weighing 1.8 kg (4 lb). With a lighter motor (that also can be high power), a weight w/o power pack of 1.3kg (3 lb) will be possible.

6.6. Future

I hope that in the future better power packs will be available. Mollicell^(tm) rechargeable lithium cells would offer not only more energy at the same weight, but a possibility to make a "fuel-gauge." A non-rechargeable lithium power pack would be a useful thing for emergency use (rescue operations), producing a huge number of holes with a lightweight power pack. For these you will need a low-power drill or a power control, because they give only some 40 Watts/lb (90 W/kg) (state of the art 1987; maybe they are better now).

In Review:

THE DESIGN OF BROAD-BAND VLF RECEIVERS WITH AIR-CORE LOOP ANTENNAS by Evans W. Paschal, Stanford Univeristy. Second edition May 1988. 89 pages.

This important reference on theory and design of VLF receivers contains many aspects that cave radio builders have not considered. The author's receiver was designed to detect "whistlers" and other VLF atmospheric phenomena, and is optimized for wide dynamic range to suppress intermodulation products. The design consideration discussed are especially relevant to frequency-agile cave radios. [contributed by Frank Reid]

\$5.00 from the author: Ev Paschal
Sinclair Island
Anacortes WA 98221

--

TRANSMITTING ANTENNAS AND GROUND SYSTEMS FOR 1750 METERS. edited by Mike Mideke (1987) 60 pages.

A leading experimenter on 160-190 kHz has collected articles from THE LOWDOWN and other LF/VLF newsletters, about the most difficult and critical aspect of successful operation in that band. Beginners and experts will value this reference on

[Continued on back page.]

THE GLOBAL POSITIONING SYSTEM (GPS)

D. McClintock, Calgary, Alberta.

Over the next three years (1989-92), many more satellites for the GPS will be launched by the United States Dept. of Defence. The aim of the system is to provide accurate, real-time, continuous positioning for all military activities, from missile navigation to infantry movements. However, this system is not solely for the use of the military. It will be available to civilian users, and a rapid decline in the price of receiver hardware is confidently predicted to yield the \$500.00 receiver by the turn of the century. Along with advances in communications technology (which will allow other people to monitor where you and your receiver are), GPS will have many applications in areas such as transport fleet monitoring and emergency services management. Clearly, there are applications in back-country navigation, position-finding, and emergency services. Maybe we will get to the stage where hikers are not allowed in the back-country without such a receiver and communications!

Current System Status.

For the last 4 years there have been 5 to 8 satellites in operation providing from 4 to 10 hours

per day of coverage depending on the application. Most use has been for static survey applications with some off-shore use in remote areas, or as a back-up system. With full availability of the "P-code" signal, single point positioning as good as a few metres is being routinely obtained. Differential positioning is available, to a few centimetres over baselines less than 50 km, and to distances of less than 1 m. over baselines of several hundred kilometres.

The current launch schedule indicates full system deployment by 1991.

Current receivers are "transportable" rather than portable, but the hardware is progressing rapidly. At a conference in Sept. 1988, an announcement was made that a design contract for a 2-frequency, 2-channel, P-code receiver the size of a cigarette package has been completed and it will be in production in a year's time. While this unit is initially slated for military use, it is forecast to be available to the general public in 1995 for \$3 - 4,000.00.

THE ATOMIC ADVENTURE OF DENNIS DRAIN

This is the tale of Dennis Drain
Who had a most fantastic brain.
Not only could he read and write
But you could get him to recite
A poem long and rather low
Concerning Nell - an eskimo.
He'd say, without the slightest fuss,
'The Leith police dismisseth us'
And no one was as slick as he
At clever wit and repartee
And many times some stupid clot
The snappy two word answer got.

But Dennis was a chappie who
Had lately joined a caving crew
And straightaway set out, all alone
To raise its intellectual tone
'You caving bods,' he'd often state
'Are technically out of date
Your methods obsolete restrict yer
And life presents a dismal picture
To probe for caves you should begin
With instruments, long, sharp and thin
Like chappies who, without assistance
Discover caves by earth resistance
And thus predict, with theory sure
Their size and shape, and furthermore
Produce convincing reasons bright
When digging fails to prove them right.'

Thus every night, when normal blokes
Were drinking beer and swopping jokes
And propping up the local bar
And singing songs like 'Caviar'
The caving types would stay at home
And read some intellectual tome
Or study figures full of gen
Within 'La Vie Parisienne'
And midst it all, our Dennis Drain
Would flog his superhuman brain
And cunning apparatus make

Until he made his bonce-piece ache.
His equal nowhere could be found
To twist and twirl his wits around.
At last 'twas done, and all the club
Retired then to the nearest pub.
Released from their intensive thinking
They caught up rapidly on drinking
While to the rest our Dennis Drain
Proceeded smartly to explain.

'I've got,' said he, with some aplomb,
'One army surplus atom bomb
Which I have fixed, with brackets neat
Quite firmly to our outhouse seat
And when I move this graphite bolt
'Twill go off with a decent jolt
And, over at Mendip's mighty face
I've fixed precisely into place
A microphone assortment vast
Recording the resultant blast.
The force of the explosion's shock
Transmitted through the band of rock
Will be from every cave reflected
And by the microphones detected.
All caves neath Mendip thus will be
Discovered simultaneously!'

They stood him beer, they bought him rum,
They sang right through 'Cathuselum'
And Dennis told them all a ditty
Not even known to the Committee
And told a brief but subtle joke
Involving a commercial bloke
But oh, alas! To put it crude
Our Dennis got disgusting slewed
By knocking back the crafty flagon
Where he'd been lately on the waggon.
His constitution, out of gear
And quite unused to rum and bear,
Got baffled when he switched to rough
And Dennis wallowed in the stuff

Then staggered out with full intent
To try his great experiment.

Soon bods within the cavers room
Were troubled by a sudden boom
And mid the noise and fearsome blast
They saw an outhouse whizzing past
And Dennis Drain, with frantic calls
Was plainly heard to shout out loud.

Consider now the situation
Resulting from the detonation.
For, by a stroke of fortune bad
The largest cave on Mendip had
For ages, undiscovered lain
Beneath the hut and Dennis Drain.
Its roof, worn thin by slow erosion,
Got shattered by the bomb's explosion
And set the caving hut adrift
Which hurtled downwards, like a lift
To finish, several seconds later,
Right at the bottom of the crater
And now the only hut to which
You enter by a ladder pitch
While climbing guests, without a care,
Abseil to it through the air
Descending placid and aloof
And landing gently on the roof.

Meanwhile, upon Mount Palomar,
Observers saw a shooting star
Which caused on careful calculation
A scene of utter consternation
And learned bods, with frantic eye,
Said 'There's an outhouse in the sky
Which orbits round the earth like heck
A thousand miles above the deck,
And inside, clinging to the chain,
Is setting Dennis (Sputnik) Drain
Who into space a way did pave
Through trying hard to find a cave.

--
from Reflections - A Look at 'Spelaeodes' and Other Caving Segas by 'Alfie' (1971, Cheddar Valley Press, Cliff Street, Cheddar, Somerset.)

optimizing the efficiency of electrically-short transmitting antennas (license-free operation at 1750m in the U.S. is limited to 1 watt transmitter power and maximum antenna length of 15 meters).
[contributed by Frank Reid]

\$5.00 from: Michael Mideke
Box 123
San Simeon, California 93452
--

GEOPHYSICAL TECHNIQUES FOR SENSING BURIED WASTES AND WASTE MIGRATION. by R.C. Benson, R.A. Glaccum, M.R. Noel
Report EPA-600/7-84-064. US Environ. Prot. Agency, Las Vegas, Nevada 89114
225 p, 118 figs. 9 tables.

Six geophysical techniques are described; metal detection, magnetometry, ground penetrating radar, electromagnetics, resistivity, and seismic refraction. All the techniques are in common use for sensing buried waste and this document compares the methods, their strong points and weaknesses. Lots of pictures of actual field operation. Some of this material must be directly applicable to finding caves!
[contributed by Ian Drummond]
--

2.3 MEGAWATT ELF TRANSMITTER

The April 1988 edition of Popular Communications has an account of a visit to the US Navy transmitter in Wisconsin. The carrier frequency is 76 Hz and in the transmitter building the visitor could actually hear as the 2.3 Mw FSK signal shifted from 72 to 80 Hz! The antenna system is in two major sections 148 miles (240 km) apart. One section is 28 miles (45 km) of 1" (2.54 cm) aluminum cable strung in a giant "X", 25 to 30 feet (9 m) above ground. The other section is 56 miles (90km) of cables strung as a giant "F". The system is used to send signals to submerged submarines, and it takes 15 minutes to send a three-letter code group. The ultimate underground radio?
[contributed by Ian Drummond]
--

EARTH-RETURN TELEPHONE FOR CAVE RESCUE. Caves & Caving (Bulletin of British Cave Research Association) No. 40, Summer 1988 p. 36.

The Australian "Michie Phone" high-impedance single-wire cave phone (see SPELEONICS 4) is upgraded with the addition of a ringer circuit. (U.S. rescuers who recently evaluated improvised phones agreed that ringers are necessary, especially on long rescues.) A NE556 IC generates tone, also has a signal-tracer mode where it beeps every three seconds, a valuable aid to finding broken wires.
[contributed by Jim Quinlan]
--



SPELEONICS
P.O. Box 5283
Bloomington, Indiana
USA 47407-5283

Bulk Rate
U. S. Postage
PAID
Bloomington, IN
Permit No. 202